

Menu structure of the paperless recorder



⇒ Chapter 8 "Device Manager"



⇒ Chapter 7 "Memory Manager"



⇒ Chapter 6 "Alarm and Event Lists"



⇒ Chapter 4 "Visualization"



⇒ Chapter 5 "Memory Presentation (History)"

Contents

| | | |
|----------|---|-----------|
| 1 | Introduction | 9 |
| 1.1 | Preface | 9 |
| 1.2 | Arrangement of the Documentation | 10 |
| 1.3 | Typographical Conventions | 12 |
| 2 | Instrument Description | 15 |
| 2.1 | Displays and Controls | 17 |
| 2.2 | Analog Inputs | 20 |
| 2.3 | Binary Inputs/Outputs | 21 |
| 2.4 | Relay Outputs | 22 |
| 2.5 | Counter/Integrators | 22 |
| 2.5.1 | Counter | 23 |
| 2.5.2 | Integrators | 23 |
| 2.5.3 | Operating time counter | 24 |
| 2.5.4 | High-speed counters | 24 |
| 2.5.5 | Flow rate quantity | 24 |
| 2.5.6 | Recording period of the counts | 25 |
| 2.5.7 | Reset counters | 26 |
| 2.5.8 | Response to setting the time | 26 |
| 2.5.9 | Response to instrument reconfiguration | 27 |
| 2.5.10 | Response to reconfiguration of the counters on the instrument | 27 |
| 2.5.11 | Response to reconfiguration of counters with setup program | 27 |
| 2.6 | Math/Logic Module | 28 |
| 2.7 | Binary Signals | 31 |
| 2.8 | Operating Modes | 34 |
| 2.8.1 | Normal, Timed, and Event Mode | 34 |
| 2.8.2 | Eco mode | 35 |
| 2.9 | Data Storage | 37 |
| 2.10 | Reading out Data | 39 |
| 2.11 | Archiving and Evaluating Data | 40 |
| 3 | Operating Principle | 43 |
| 3.1 | Operating Principle and Graphic Elements | 43 |
| 3.2 | Operating Example | 48 |

Contents

| | | |
|------------|---|-----------|
| 3.3 | Group and Plant Management (Batches) | 50 |
| 4 | Visualization | 53 |
| 4.1 | Activating the Operator Level | 53 |
| 4.2 | Overview of Header Lines | 54 |
| 4.3 | Curve Presentation | 55 |
| 4.4 | Bar Graph Presentation | 56 |
| 4.5 | Text Picture Presentation | 57 |
| 4.6 | Process Image Presentation | 58 |
| 4.7 | Binary diagram presentation | 58 |
| 4.8 | Reports | 59 |
| 4.9 | Batches/Plants | 60 |
| 4.9.1 | Current Batches | 60 |
| 4.9.2 | Completed Batches | 62 |
| 4.9.3 | Batch Control with Barcode Reader | 63 |
| 4.10 | Counters and Integrators | 66 |
| 4.11 | Comment Entry | 67 |
| 5 | Memory Presentation (History) | 69 |
| 6 | Alarm and Event Lists | 73 |
| 6.1 | Call from One of the Visualization Modes | 74 |
| 6.2 | Call from the Memory Presentation | 76 |
| 6.3 | Symbols | 76 |
| 7 | Memory Manager | 77 |
| 8 | Device Manager | 81 |
| 8.1 | Close Device Manager | 82 |
| 8.2 | Log-in and Log-out | 82 |
| 8.3 | Device information | 84 |
| 8.4 | Device Audit Trail | 89 |

Contents

| | | |
|-------------|--|------------|
| 8.5 | Configuration | 90 |
| 8.6 | Parameterization | 90 |
| 8.7 | Service | 91 |
| 9 | Parameterization | 93 |
| 9.1 | Fine calibration | 94 |
| 9.2 | Counters/integrators | 94 |
| 9.3 | Date and time | 94 |
| 9.4 | Batches/plants | 95 |
| 10 | Configuration - General | 97 |
| 11 | Configuration - Device Data | 99 |
| 12 | Configuration - Screen | 101 |
| 12.1 | Brightness ... Show text image | 101 |
| 12.2 | Show process image ... Bar code -> current batch | 102 |
| 13 | Configuration - Analog Inputs | 105 |
| 13.1 | Sensor ... Offset | 105 |
| 13.2 | Filter Constant ... Unit | 106 |
| 13.3 | Comma format ... Alarm Configuration | 108 |
| 13.4 | Alarm configuration | 109 |
| 13.4.1 | Status ... Alarm text 2 | 109 |
| 13.4.2 | Alarm rejection | 110 |
| 14 | Configuration - Binary Inputs/Outputs | 111 |
| 14.1 | Function ... Alarm Configuration | 111 |
| 14.2 | Alarm Configuration | 112 |
| 15 | Configuration - Relay | 115 |

Contents

| | | |
|-----------|---|------------|
| 16 | Configuration - External Analog Inputs | 117 |
| 16.1 | Range Start ... Alarm Configuration | 117 |
| 16.2 | Alarm configuration | 118 |
| 16.2.1 | Status ... Alarm text 2 | 118 |
| 16.2.2 | Alarm rejection | 120 |
| 17 | Configuration - External Binary Inputs | 121 |
| 17.1 | Channel Name ... Alarm Configuration | 121 |
| 17.2 | Alarm Configuration | 122 |
| 18 | Configuration - Groups | 125 |
| 18.1 | Parameter | 126 |
| 18.2 | Analog Channels | 127 |
| 18.3 | Binary Channels | 130 |
| 18.4 | Counters/Integrators | 130 |
| 18.5 | Diagram View | 131 |
| 18.6 | Normal Operation | 133 |
| 18.7 | Event Mode | 135 |
| 18.8 | Timed Mode | 136 |
| 19 | Configuration Report | 137 |
| 19.1 | Total ... Period | 137 |
| 19.2 | External ... Out of range | 139 |
| 20 | Configuration - Limit Monitoring | 141 |
| 20.1 | Function ... Alarm Configuration | 141 |
| 20.2 | Alarm Configuration | 143 |
| 21 | Configuration - Counters/Integrators | 145 |
| 21.1 | General Setting | 145 |
| 21.2 | Function ... Specific Setting | 147 |
| 21.3 | Input Signal ... Decimal Place | 149 |

Contents

| | | |
|-------------|--|------------|
| 21.4 | Range Start ... Alarm Configuration | 151 |
| 21.5 | Alarm Configuration | 152 |
| 22 | Configuration - Interface | 155 |
| 22.1 | Ethernet | 156 |
| 22.2 | RS232/RS485 | 158 |
| 22.2.1 | General | 158 |
| 22.2.2 | Modbus master | 159 |
| 22.3 | RS232 for Barcode Reader | 161 |
| 23 | Configuration – Batches/Plants | 163 |
| 23.1 | General Information on Batches | 163 |
| 23.2 | General Plant Parameters | 165 |
| 23.3 | Plant 1 – 3 | 166 |
| 23.3.1 | General | 166 |
| 23.3.2 | Lines 1 – 10 | 168 |
| 23.4 | Final Remarks | 171 |
| 24 | Configuration - Date and Time | 173 |
| 24.1 | Time Synch. ... Daylight Saving Time | 173 |
| 24.2 | Start Daylight Saving | 175 |
| 24.3 | End Daylight Saving | 176 |
| 25 | Configuration - Undocumented Parameters | 177 |
| 26 | Entering text and values | 179 |
| 26.1 | Text entry | 179 |
| 26.1.1 | Entering characters | 179 |
| 26.1.2 | Insert spaces | 181 |
| 26.1.3 | Delete character | 181 |
| 26.1.4 | Move cursor | 181 |
| 26.1.5 | Enter text from text list | 181 |
| 26.1.6 | Finish entry | 181 |
| 26.1.7 | Reject entry | 182 |
| 26.2 | Entry via selection field | 182 |

Contents

| | | |
|-------------|--|------------|
| 26.3 | Entering values | 183 |
| 26.3.1 | Whole numbers (integers) | 183 |
| 26.3.2 | Real numbers (floating point) | 184 |
| | | |
| 27 | Web server | 185 |
| 27.1 | General | 185 |
| 27.2 | Online Visualization (All Visualizations Except Batches) | 188 |
| 27.3 | Three freely programmable HTML pages | 190 |
| 27.4 | Online Visualization of Current Batch Reports | 191 |
| 27.5 | 4-Way View | 192 |
| | | |
| 28 | Appendix | 195 |
| 28.1 | Bar code | 195 |
| 28.1.1 | Batch control | 195 |
| 28.1.2 | Batch texts | 196 |
| | | |
| 29 | Index | 199 |

1.1 Preface



Please read this manual before commissioning the instrument. Keep the instructions in a place which is accessible to all users at all times.

Please assist us in improving these instructions where necessary.

Your comments will be appreciated.



If any difficulties should arise during commissioning, you are asked not to carry out any manipulations that could endanger your rights under the instrument warranty!

Please contact the nearest subsidiary or the head office in such a case.



When returning modules, assemblies or components, the regulations of EN 61340-5-1 and EN 61340-5-2 "Protection of electronic devices from electrostatic phenomena" must be observed. Use only the appropriate **ESD** packaging for transport.

Please note that we cannot accept any liability for damage caused by ESD.

ESD = Electro Static Discharge

1 Introduction

1.2 Arrangement of the Documentation

The documentation for this instrument is addressed to equipment manufacturers (OEMs) and users with appropriate technical expertise. It consists of the following parts:

Instrument documentation in printed form

59486 Operating instructions

The operating instructions are an extract from the operating manual and cover the basic operation of the paperless recorder.

59488/59490 Installation instructions

The installation instructions describe the installation of the recorder and the connection of the supply and signal cables. The instructions also contain a list of the technical data.

59488 Installation instructions for recorder with zinc die-cast panel

59490 Installation instructions for recorder with stainless steel panel

Instrument documentation in the form of PDF files

The “Instrument documentation in the form of PDF files” is on the CD that is included in the delivery.

59484 Operating manual

It contains information about commissioning, operation and parameterization on the instrument, as well as about the setup program (available as an option).

59486 Operating instructions

The operating instructions are an extract from the operating manual and cover the basic operation of the paperless recorder.

59494 Interface description (serial interfaces)

This provides information on communication (RS 232/RS 485) with supervisory systems.

Interface description (Ethernet interface)

This provides information on the connection of a paperless recorder to a company-internal network. This description is integrated into 59494.

59496 Interface description (PROFIBUS-DP interface)

This provides information on the connection of a paperless recorder to a PROFIBUS-DP system.

59488/59490

Installation instructions

The installation instructions describe the installation of the recorder and the connection of the supply and signal cables. The instructions also contain a list of the technical data.

59488 Installation instructions for recorder with zinc die-cast panel

59490 Installation instructions for recorder with stainless steel panel

59492

Setup program

These instructions describe the functions of the setup program. The setup program is available as an accessory.

DS-DV7-1-EN-1202

Data sheet

The data sheet contains general information, the order details and, technical data.

59498

PC evaluation software PCA3000

The operating manual describes the operation and the features of the PC evaluation software.

The PC evaluation software serves to visualize and evaluate process data (measurement data, batch data, messages ...). The process data can be read in via the CompactFlash memory card, or made available through the PCC software.

59500

PCA communications software PCC

The operating manual describes the operation and features of the PCA Communications software.

The PCA Communications software is responsible for the data transfer from the paperless recorder to a PC, or across a network.

1 Introduction

1.3 Typographical Conventions

Warning signs

The signs for **Danger** and **Caution** are used in this manual under the following conditions:



Danger

This symbol is used when there may be **danger to personnel** if the instructions are ignored or not followed correctly!



Warning

This symbol is used when there may be **damage to equipment or data** if the instructions are ignored or not followed correctly!



Warning

This symbol is used where special care is required when handling **components liable to damage through electrostatic discharge**.

Note signs



Note

This symbol is used when your **special attention** is drawn to a remark.



Reference

This symbol refers to **further information** in other manuals, chapters or sections.

abc¹

Footnote

Footnotes are remarks that **refer to specific points** in the text. Footnotes consist of two parts:

A marker in the text, and the footnote text.

The markers in the text are arranged as continuous superscript numbers.

Action instruction

*

This symbol indicates that an **action to be performed** is described.

The individual steps are marked by this asterisk, e.g.

* Rotate control knob

* Press control knob

Presentation modes

Screen texts

*Program
manager*

Texts that are displayed in the setup program are indicated by **italic script**.

Menu items

*Edit →
Device data*

Menu items in the setup and instrument software referred to in this operating manual are shown in italics. Menu name, menu item and submenu item are separated from each other by “→”.

1 Introduction

2 Instrument Description

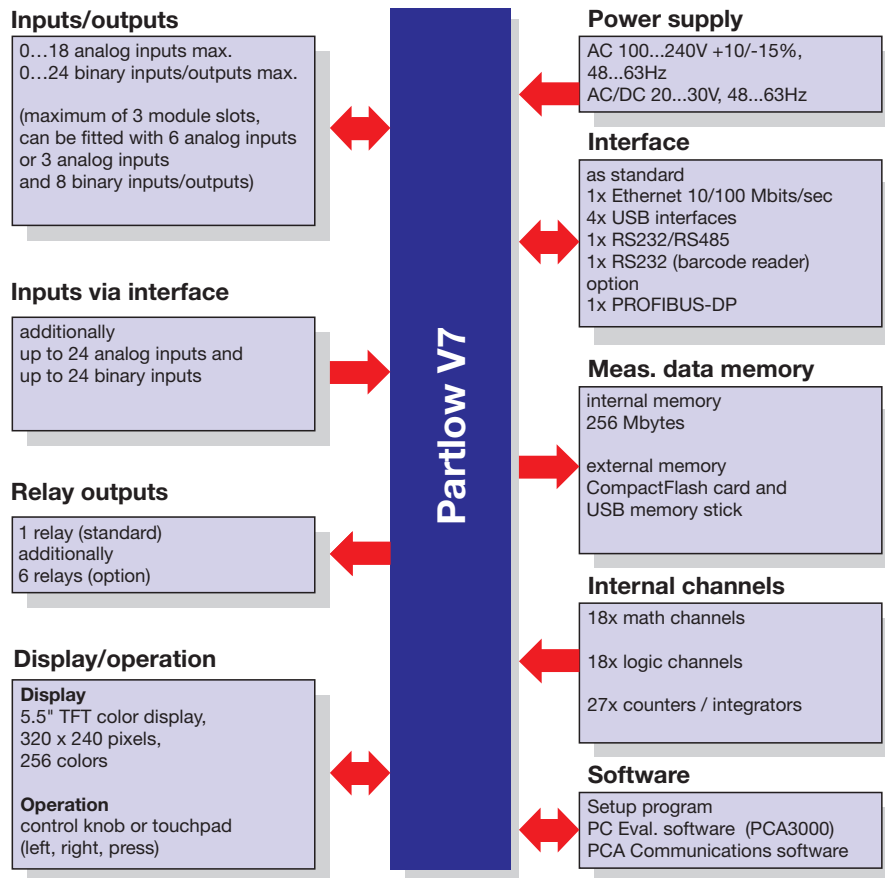

The connection diagram is described in the Installation Instructions 59488/59490. When the paperless recorder is delivered, a printed version of the installation instructions is included.

| | |
|-------|---|
| 59488 | Installation instructions for recorder with zinc die-cast panel |
| 59490 | Installation instructions for recorder with stainless steel panel |

2 Instrument Description

Device features

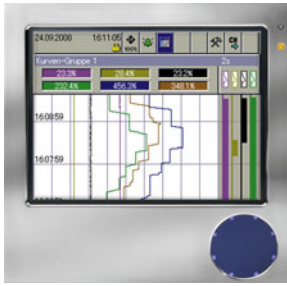
| | | |
|-------------------------------------|--|---|
| |  |  |
| Front panel | Zinc die-cast with lid | Stainless steel (enclosed) |
| Interfaces located on front panel | 2x USB | None |
| External memory | CF-card located on front panel, maximum 4 GB | None |
| Operation | Control knob | Touchpad |
| Interfaces located on device's rear | 2x USB, 1x RS232/RS485, 1x RS232, 1x Ethernet, 1x PROFIBUS-DP (option) | 2x USB, 1x RS232/RS485, 1x RS232, 1x Ethernet, 1x PROFIBUS-DP (option) |
| Special features | Tested acc. to KTA 3505 | |

2 Instrument Description

2.1 Displays and Controls

Recorder with
zinc die-cast
panel

Power LED (green)
is on continuously as soon as power is applied.

TFT color display
320 x 240 pixels, 256 colors

Status LED (red)
is on continuously
if an alarm is present.

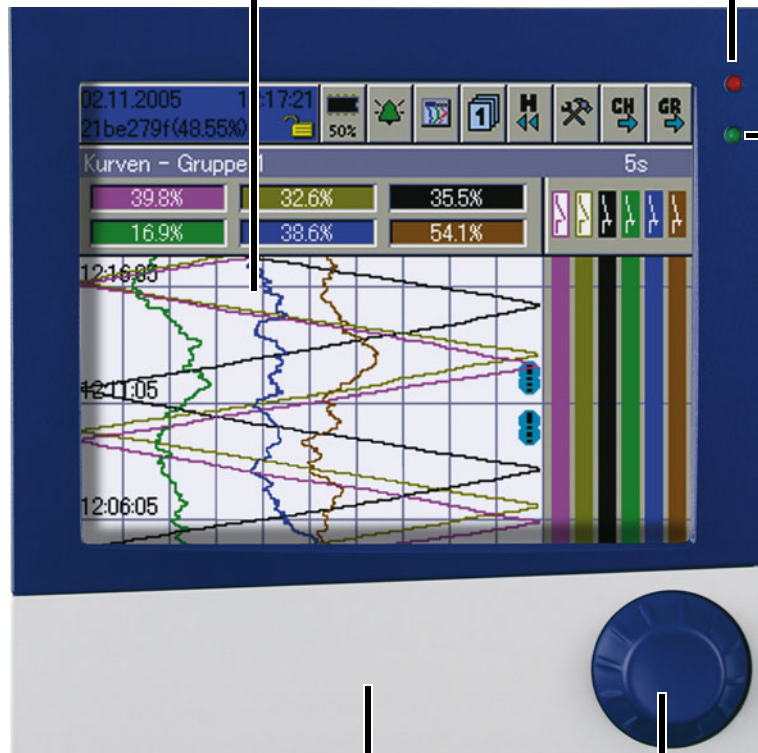

Cover
for the CompactFlash® slot¹
and the setup plug connection

Control knob
The control knob is used to configure and operate the
paperless recorder. It can be rotated in both clockwise
and anti-clockwise directions, and pressed.

¹. CompactFlash® is a registered trademark of the SanDisk Corporation.

2 Instrument Description

Recorder with zinc die-cast panel

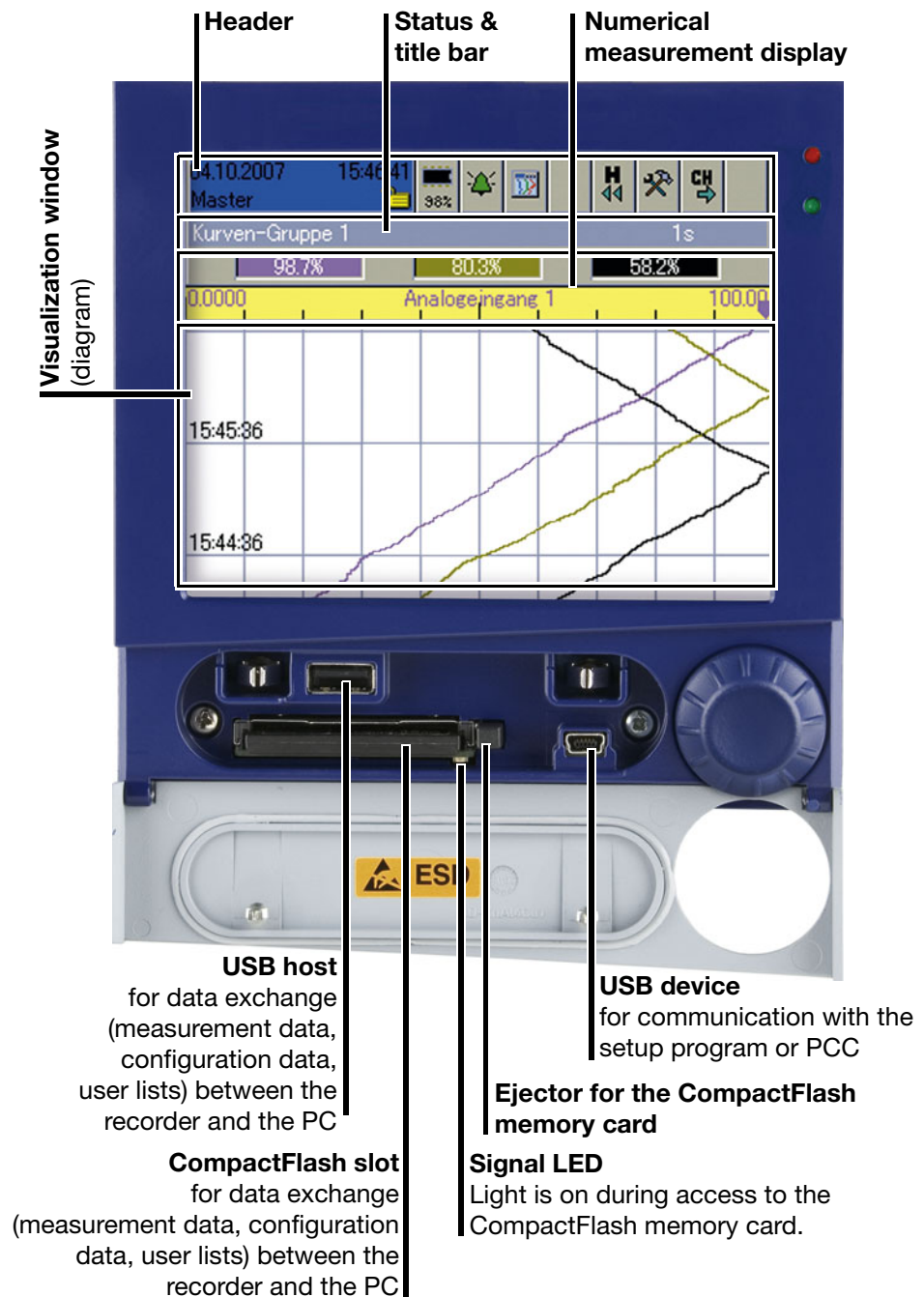

The CompactFlash memory card must not be removed during access (signal LED is on).

The USB interfaces are **not** designed for continuous use.



The life of the background illumination can be prolonged by using the parameter "Screen off".

2 Instrument Description

Recorder with stainless steel panel

Power LED (green)
is on continuously as soon as power is applied.

TFT color display
320 x 240 pixels, 256 colors

Status LED (red)
is on continuously if an alarm is present.

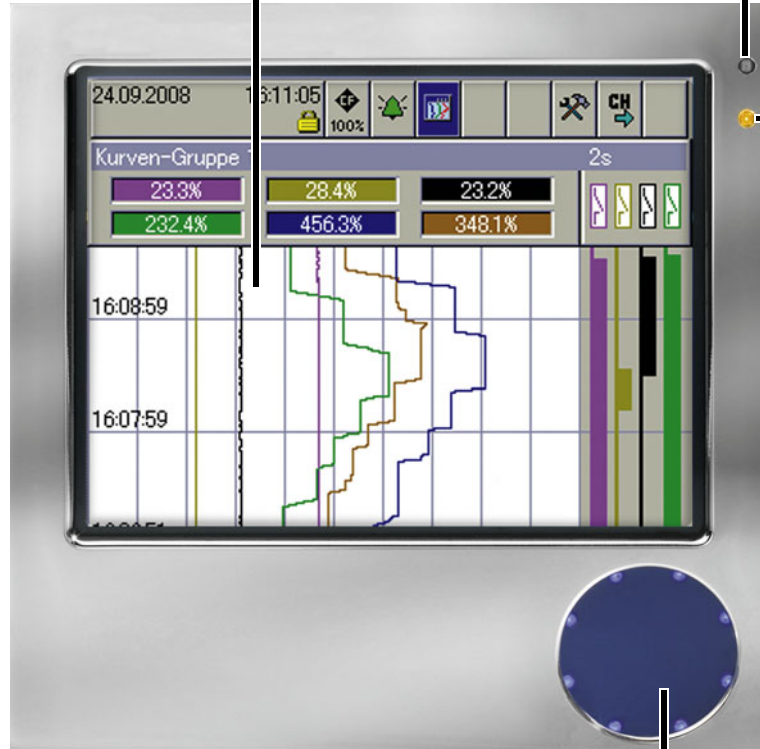

Touchpad
The touchpad is used to configure and operate the recorder. A circular motion with a finger at the outer edge has the same effect as the turning of the control knob. Tapping the middle of the touchpad has the same effect as when the control knob is pressed.

All descriptions of the control knob in this operating manual also apply to the touchpad.



For recorders with a stainless steel panel (option) the Compact-Flash memory card is not available as external memory. The measured data can be saved through one of the interfaces or through a USB flash drive (on the rear side).

No interfaces at the front panel are available.

The installation instructions from 59490 are to be heeded and complied with.

2 Instrument Description

2.2 Analog Inputs

Internal analog inputs

The paperless recorder can be equipped with 0 to 18 analog inputs. During configuration, they are designated **Analog input 1 – 18**.

There are two ways of finding out the exact number of analog inputs that have been integrated:

- Check the type code on the nameplate against the type designation. Please refer to the Installation Instructions 59488 for an explanation of the nameplate and type designation.
- Read the information on the instrument, in the menu *Device manager* → *Device info* → *Hardw.*

In addition to the internal analog inputs, external analog inputs can also be connected to the recorder.

External analog inputs

External analog inputs can be connected to the recorder via three different interfaces. When configuring the external analog inputs, these are designated **External analog input 1 – 24**.

Serial interface RS232/RS485 (Modbus)

The measured values of the external inputs can be transmitted to the recorder via these two serial interfaces. The paperless recorder can be operated either as a Modbus slave or as a Modbus master.

Further information on using the serial interface can be found in the Interface Description 59494.

Ethernet interface

Further information on using the serial interface can be found in the Interface Description 59494.

PROFIBUS-DP

This requires the option PROFIBUS-DP interface.

Further information on using the PROFIBUS-DP interface can be found in the Interface Description 59496.

2.3 Binary Inputs/Outputs

Internal binary inputs/outputs

The recorder can be equipped with 0, 8, 16 or 24 binary inputs/outputs. During configuration, they are designated **Binary input/output 1 – 24**. The function (input or output) can be configured.

There are two ways of finding out the exact number of binary inputs/outputs that have been implemented:

- Check the type code on the nameplate against the type designation. Please refer to the Installation Instructions 59488 for an explanation of the nameplate and type designation.
- Read the information on the instrument, in the menu *Device manager* → *Device info* → *Hardw.*

In addition to the internal binary inputs/outputs, external binary inputs can also be connected to the recorder.



Only external binary inputs are supported, but no external binary outputs.

External binary inputs

External binary inputs can be connected to the recorder via three different interfaces. When configuring the external binary inputs, they are designated **External binary input 1 – 24**.

Serial interface RS232/RS485 (Modbus)

The states of the external inputs can be transmitted to the recorder via these two interfaces. The paperless recorder can be operated either as a Modbus slave or as a Modbus master.

Further information on using the serial interface can be found in the Interface Description 59494.

Ethernet interface

Further information on using the serial interface can be found in the Interface Description 59494.

PROFIBUS-DP

This requires the option PROFIBUS-DP interface.

Further information on using the PROFIBUS-DP interface can be found in the Interface Description 59496.

2 Instrument Description

2.4 Relay Outputs

A maximum of 7 relays (1 as standard, 6 as an extra) is available to signal, for instance, alarms or limit infringements. The action can be configured as break (SPST-NC) or make (SPST-NO) contact.

There are two ways of finding out whether the 6 additional relays are available:

- Check the type code on the nameplate against the type designation. Please refer to the Installation Instructions 59488 for an explanation of the nameplate and type designation.
- Read the information on the instrument, in the menu *Device manager* → *Device info* → *Hardw.*

2.5 Counter/Integrators

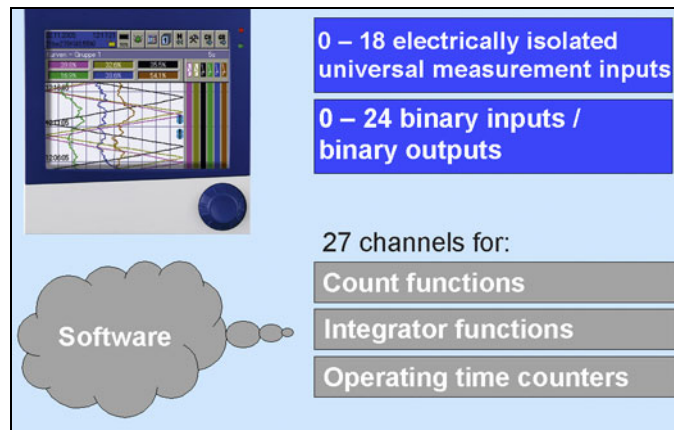

These are **not** electrical measurement inputs (hardware), but channels which are calculated by the paperless recorder (software).

The terms counter and integrators encompass the following elements:

- Counter
- Integrators
- Operating time counter
- High-speed counter (hardware counter)
- Flow rate quantity

2.5.1 Counter

| | |
|---------------------------|---|
| Counter inputs | <ul style="list-style-type: none">- Binary inputs- Alarms- Errors- ... <p>⇒ Chapter 2.7 “Binary Signals”</p> |
| Counting frequency | 8Hz max. |
| Weighting | Counted pulses are weighted by multiplying them by a factor. A down counter can be implemented by entering a negative weighting (e.g. weighting factor -1). |

2.5.2 Integrators

| | |
|---|---|
| Integrator inputs | <ul style="list-style-type: none">- Analog inputs |
| Integrator time base | <ul style="list-style-type: none">- sec, min, hr and day |
| Weighting | Integrators are weighted by multiplying them by a factor. Negative integration can be implemented by entering a negative weighting (e.g. a weighting factor of -1). |
| Weighting example | <ul style="list-style-type: none">- Flow rate- Input signal of 0 ... 20mA corresponds to a flow rate of 0 ... 1000 liters/sec- Time base 1 sec- Weighting 0.001 (conversion from liters to m³)- Display of the integration value (flow rate quantity) in m³ <p> This type of flow measurement is based on an analog input. Fast binary inputs offer another possibility (high-speed counters).</p> <p>⇒ Chapter 2.5.5 “Flow rate quantity”</p> |
| Minimum size of the input signal | Entering a threshold (amount of the threshold value) has the effect that integration takes place only when the value has been exceeded. No integration will occur on falling below this value. The advantage of integration with a threshold value larger than 0 is that possible noise from a transducer can be suppressed in this way. |

2 Instrument Description

2.5.3 Operating time counter

The operating time counter will count how long a selected binary input or one of the binary signals is closed. The time can be displayed in sec, min, hr and days.

2.5.4 High-speed counters

Counter inputs The first two binary inputs of each module (B1, B2, B9, B10, B17, B18) can be counted. Binary inputs are available if the module is fitted with 3 analog inputs and 8 binary inputs.

Counting frequency Max. 10kHz

Weighting Counted pulses can be weighted (by multiplying them by a factor). A down counter can be implemented by entering a negative weighting (e.g. weighting factor -1).

2.5.5 Flow rate quantity

This makes use of the options of existing counter function to determine flow rate quantities with the high-speed counters over the assigned time intervals (the "pulses within the time base" are multiplied by the "weighting").



The flow rate quantity only appears on the paperless recorder. It is not saved.

Counter inputs The first two binary inputs of each module (high-speed counters B1, B2, B9, B10, B17, B18) can be used to measure the flow rate quantity (pulse counting). Binary inputs are available if the module is fitted with 3 analog inputs and 8 binary inputs.

Time base sec, min, hr and day

The time base defines the duration for which pulses will be counted (gate time) and the display interval of the flow rate quantity.

Counting frequency Max. 10kHz

Weighting Counting pulses can be weighted (by multiplying them by a factor). A down counter can be implemented by entering a negative weighting (e.g. weighting factor -1).

2.5.6 Recording period of the counts

For all counters, integrators, operating time counters, and high-speed counters, the counters are concluded and the counter states are stored and restarted after an adjustable amount of time (recording time period). The counter states of the most recently completed recording period can be numerically displayed.

The following counter/integrator types are possible:

- Periodic
In addition, the time period (from 1 min to 12 hrs) must be selected in the parameter *Configuration → Counters/Integrators → General settings → Period*.
- External
In this case, the counter/integrator is updated only when the selected control signal is active (e.g. binary input is closed). When the control signal is deactivated (e.g. binary input is opened), the counter/integrator value is saved and reset to 0.
- Daily
- Weekly
- Monthly
- Yearly
- Total
- Daily (start – end)
In addition, the time period must be selected through the two parameters *Configuration → Counters/Integrators → General settings → Start* and *Configuration → Counters/Integrators → General settings → End*. The counter/integrator will then only be updated from the start time. When the end time has been reached, the counter/integrator value is saved and then reset to 0.

2 Instrument Description

2.5.7 Reset counters

Periodic reset There is a recording time period for each counter, integrator, operating time counter and high-speed counter. At the end of this period, the current data (value and time) are saved and the value reset to 0. Then the next time period is recorded.

The overall and annual counters/integrators are an exception. These are saved whenever any count/integration has been completed, but not reset to 0. This means that they can be evaluated in the evaluation software PCA3000 as well.

External reset A control signal can be configured for all counters, integrators, operating time counters and high-speed counters. The signal generates a reset of the counter states to 0 without previous values being saved. The period for the summation will be restarted at this point. This means that after the test run of an installation, for instance, the recording can be freshly started; the test run values that are not required are eliminated.

⇒ Chapter 21.1 “General Setting”

⇒ Chapter 21.3 “Input Signal ... Decimal Place”

Reset from control knob The parameterization menu makes it possible to set counter states to a specific value. The precondition is that a user is logged in to the device. When the value is entered after editing, a message with the new and the old count value is entered in the event list.

The time period for the counter/integrator summation will not be restarted. The previous counter/integrator values will also not be saved.



If you wish to save the previous counter/integrator values, you must execute the function “Save all + update CF.” in the menu for the memory manager.

In this way, the recording can be freshly started for individual counters/integrators, e.g. after the test run of an installation; the test run values that are not required will be eliminated in the process.

2.5.8 Response to setting the time

When the time is set, all counter states are completed and saved and, value is reset to 0, and the recording period is restarted.

2.5.9 Response to instrument reconfiguration

When the instrument is reconfigured, the current counter/integrator recording periods remain unaffected. The counter/integrator values will not be reset to 0 and the recording period will not be restarted.



The values can be deliberately reset, via the “Parameterization” menu.

2.5.10 Response to reconfiguration of the counters on the instrument

If a counter/integrator on the instrument is reconfigured, then only the affected counter/integrator will be concluded, saved, reset to 0 and have the recording period restarted.

If anything is changed through reconfiguration in the menu *Configuration* → *Counters/integrators* → *General settings*, then all counters/integrators are concluded, saved, the values reset to 0, and the recording period is restarted.

2.5.11 Response to reconfiguration of counters with setup program

If a counter/integrator is reconfigured, the setup program will conclude and save all counter states and reset the value to 0 and the recording period is restarted.

2 Instrument Description

2.6 Math/Logic Module

The math and logic module is available as an extra. Like the counters/integrators, the math and logic module are channels that are not available as hardware but are calculated by the instrument software.

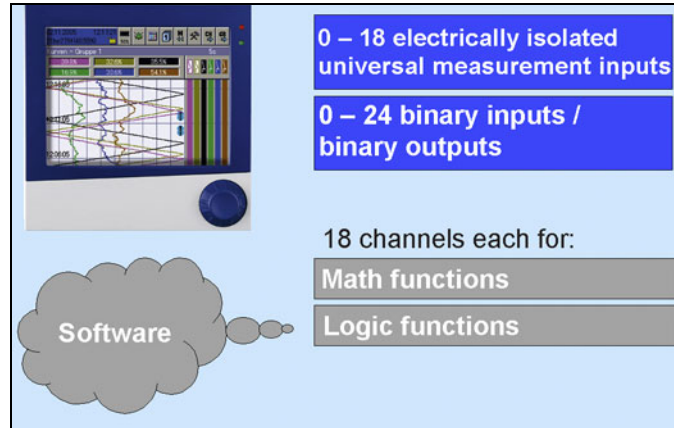

The math and logic module consists of two parts:

- the math module for calculating analog values and
- the logic module for linking Boolean values (0 or 1).

Math module

The math module provides 18 measurement inputs for calculating new “virtual” channels.

For the calculated channels, separate math channels are provided in addition to the internal analog inputs. In configuration, you have to activate the required math channel in the group configuration and thus assign it to a group.

Configuration → Group x → Analog channels → Channel x = Math x

Setupprogram

How a math channel is formed is determined through the setup program.

As variables for the formulae, the following may be available:

- Analog inputs
- Binary inputs
- Counters/integrators
- Alarms
- Errors

If counter/integrator values are used for calculation, then please note that their accuracy is reduced, since, in this case, two different data formats will have to be used for calculation. Counters/integrators are calculated in double-float format (8 bytes per value), whereas the math module employs a single-float format (4 bytes per value) according to the IEEE 754 standard. Nevertheless, it is possible to include these values in the math module.

2 Instrument Description

The following fixed functions are available:

- difference
- ratio
- relative humidity
- moving average

For the moving average, the reference channel has to be entered (in most cases, the analog input) and the time (in minutes). They will be used to calculate the moving average.

The following operators and functions are available for formulas: +, -, *, /, (,), SQRT(), MIN(), MAX(), SIN(), COS(), TAN(), **, EXP(), ABS(), INT(), FRC(), LOG(), LN().

On going above or falling below the scalable values, the math channel is treated as for "out-of-range".

Formulas are entered in the PC, in the setup program. It is not possible to edit math formulas on the instrument.



Further information can be obtained from the instructions on the setup program (59492).

Logic module

Up to 18 channels are available for the logic channels.

As is the case with all the other binary signals, the calculated digital (Boolean) values can be used for different functions:

- recording in event traces,
- as a control signal for display switch-off,
- clock time synchronization,
- operating time counter,
- externally controlled counters/integrators
- counter/integr. reset
- event mode,
- for output to a relay and
- as count input for a counter.

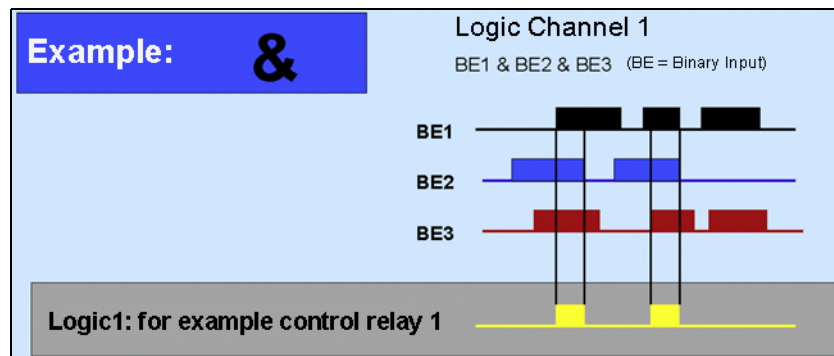

2 Instrument Description

Following are some of the variables available for formulas:

- Binary inputs
- Logic channels
- Alarms
- Errors

These functions can be used for formulas:

- ! (NOT)
- & (AND)
- | (OR)
- ^ (XOR)
- / (rising edge)
- \ (falling edge)
- ((open bracket)
-) (close bracket)



Further information can be obtained from the instructions on the setup program (59492).

2.7 Binary Signals

Binary signals are used by the recorder, for example to

- operate a relay,
- activate the Event operating mode,
- start external reports and
- start batch reports.

Binary signals are made visible as binary traces or switch symbols and can be used as a basis for counters. The binary inputs (internal and external) are binary signals.

| | |
|----------------------------------|---|
| Binary I/O | <p>The switching states of the internal binary inputs/outputs are indicated by the binary signals. Depending on the instrument hardware level, 0, 8, 16 or 24 binary inputs/outputs are available.</p> <p>⇒ Chapter 14 “Configuration - Binary Inputs/Outputs”</p> |
| Binary I/O alarm | <p>If the alarm configuration of an internal binary input/output is active, the switching state is indicated through the corresponding binary signal. Please note that the <i>Alarm type</i> must be configured for “Alarm”, and not for “Event”.</p> <p>⇒ Chapter 14.2 “Alarm Configuration”</p> |
| Relays | <p>The switching states of the internal relays (1 or 7) are indicated by the binary signals.</p> |
| Limits (limit monitoring) | <p>The result of the limit monitoring (limit 1 – 9) is indicated through the binary signals.</p> <p>⇒ Chapter 20 “Configuration - Limit Monitoring”</p> |
| Limit alarms | <p>If the alarm configuration of a limit monitoring is active, the alarm is indicated through the corresponding binary signal. Please note that the <i>Alarm type</i> must be configured for “Alarm”, and not for “Event”.</p> <p>⇒ Chapter 20.2 “Alarm Configuration”</p> |
| Batch | <p>The binary signals are used to indicate whether the corresponding batch report for plant 1 – 3 is active, i.e. whether a batch report is currently being run.</p> |
| Ext. binary input | <p>Binary signals are used to indicate the switching states of the external binary inputs. Up to 24 external binary inputs are available.</p> <p>⇒ Chapter 17 “Configuration - External Binary Inputs”</p> |
| Alarms, ext. binary input | <p>If the alarm configuration of an external binary input is active, the switching state is indicated through the corresponding binary signal. Please note that the <i>Alarm type</i> must be configured for “Alarm”, and not for “Event”.</p> <p>⇒ Chapter 17.2 “Alarm Configuration”</p> |

2 Instrument Description

Alarms, analog inputs The alarm monitoring states of the internal analog inputs are indicated by the binary signals. Depending on the instrument hardware level, up to 18 internal analog inputs are available. There are two binary alarm signals for each analog input.

⇒ Chapter 13 “Configuration - Analog Inputs”

Alarms, counters/integr. The alarm monitoring states of the counters/integrators are indicated by the binary signals. 27 counters/integrators are available. There are two binary alarm signals for each counter/integrator.

Group alarms The binary signals are used to indicate whether an infringement of the tolerance band is present within a group, or whether there is an alarm for an analog or binary channel. The individual channel alarms are OR-linked.

Infringement of tolerance band, group 1 – 9

There are two binary signals for each group:

- Alarm1 TL Group 1 – 9 = positive tolerance band infringement on a channel and
- Alarm2 TL Group 1 – 9 = negative tolerance band infringement on a channel and

⇒ Chapter 18.2 “Analog Channels”

Alarm group 1 – 9

There is a binary signal for each group:

- Alarm Group 1 – 9 = alarm for an analog or binary channel in the corresponding group.

⇒ Chapter 13.4 “Alarm configuration”

Alarms, ext. Analog inputs The alarm monitoring states of the external analog inputs are indicated by the binary signals. 24 external analog inputs are available. There are two binary alarm signals for each external analog input.

⇒ Chapter 13 “Configuration - Analog Inputs”

Combination alarm

“Combination alarm” includes the following signals:

| Signal | Description |
|--------------------|---|
| Device alarm | The signal is formed from an OR link of all alarm configurations (e.g. alarm configuration of analog inputs and binary inputs and outputs) and the PROFIBUS communication error signal. |
| Mem.al. Read CF | The signal is activated when the device-internal memory space available for data readout via CF card has fallen below the selected threshold value. ⇒ Chapter 2.10 “Reading out Data” (Mem.al. = memory alarm) |

2 Instrument Description

| Signal | Description |
|-------------------|---|
| CF card full | The signal is activated when the memory space of a CF card that has been inserted (external memory) has fallen below the selected threshold value. ⇒ Chapter 2.10 “Reading out Data” |
| Mem.al. interface | The signal is activated when the device-internal memory space available for data readout via interface has fallen below the selected threshold value. ⇒ Chapter 2.10 “Reading out Data” (Mem.al. = memory alarm) |
| Login | The signal is activated as soon as a user is logged in to instrument. ⇒ Chapter 8.2 “Log-in and Log-out” |
| Error | The signal “Error” (also referred to as system error) is activated when: <ul style="list-style-type: none"> - the CF card is faulty or full, - the device battery is empty, - the internal memory is faulty or - a p.c.b in the device has not been calibrated. |
| Reserve 1 | Currently not used. |
| Fieldbus error | The signal is activated when an error occurs during communication via PROFIBUS. |
| Reserve 2 | Currently not used. |
| CF card inserted | The signal is activated when a CF card is inserted in the instrument. |
| CF card removed | The signal is activated when a CF card is removed from the instrument. |

2 Instrument Description

2.8 Operating Modes

2.8.1 Normal, Timed, and Event Mode

The operating modes are used to determine the cycle in which measurement data are stored.

3 operating modes

The instrument has 3 operating modes:

- Normal operation
- Timed mode
- Event mode

The following settings can, among others, be made for each of the three operating modes:

- Stored value
- Storage cycle (memory rate)

Stored value

The "Stored value" parameter determines what is stored: average, minimum, maximum or momentary value between two storage cycles, or the peak value (envelope). With the "Peak value setting, the minimum and maximum value of the last storage cycle will be saved.

Another option for the stored value is "Eco mode". This is a special storage possibility, which is described separately in Chapter 2.8.2.

Storage cycle

The "Storage cycle" parameter determines the interval between two stored values. The diagram speed corresponds to the storage cycle, which means that with a storage cycle of 5sec, for example, the stored value is entered in the diagram every 5sec.

Normal operation

If the instrument is **not** in timed or event mode, normal operation is active.

Timed mode

For timed mode, a period of time can be defined (up to 24 hrs) within which a specific stored value and a specific storage cycle are active.

Event mode

Event mode is activated by a control signal that is assigned to an event or alarm. Event mode can be used, for example, to shorten the storage cycle when an alarm is present.



Priority

The respective priorities of the operating modes are allocated as follows:

| Operating mode | Priority |
|------------------|----------|
| Normal operation | Low |
| Timed mode | Medium |
| Event mode | High |

2 Instrument Description

Active operating mode The active operating mode is shown in the diagram by different symbols behind the current display for the diagram speed:

| Operating mode | Symbol |
|------------------|--|
| Normal operation | 5s |
| Timed mode | 1s  |
| Event mode | 1s  |

2.8.2 Eco mode

The parameters for Eco mode are set in the menu for normal operation. However, Eco mode can be used for all three operating modes.

In Eco mode, the momentary values (current values) are recorded in a predefined minimum storage cycle (independent of the tolerance band).

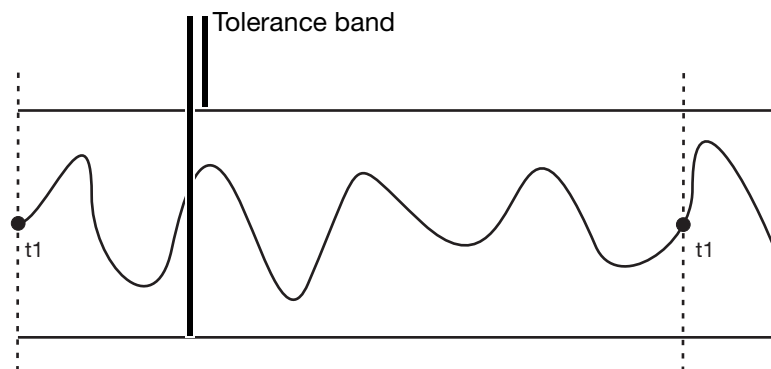

t1 = storage through "Min. storage cycle" (forced storage).

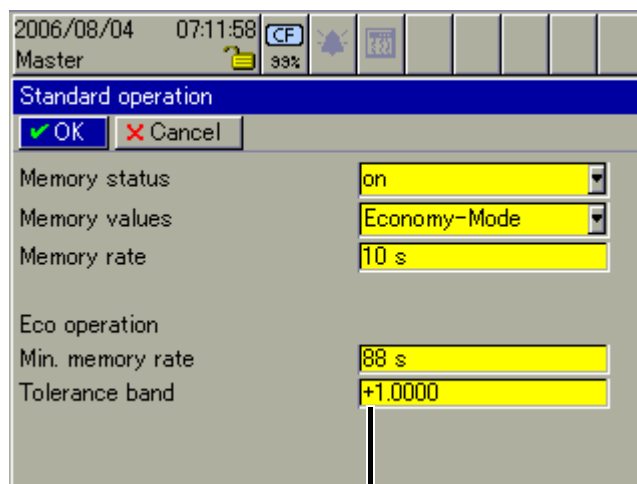

The tolerance band is specified with regard to the unit of the analog channels (e.g. $\pm 1\text{ }^{\circ}\text{C}$).

2 Instrument Description

If the measurements go outside the tolerance band, and the new measurement, which is outside the tolerance band, is present for at least the duration of the storage cycle that was set in the active operating mode, then it is acquired and stored and a new tolerance band is applied.

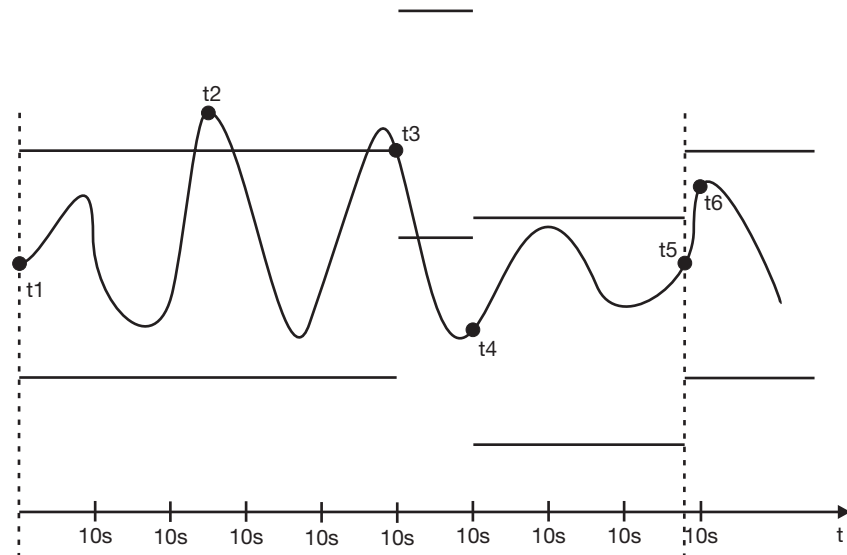

- t1 = storage through “Min. storage cycle” (forced storage) and application of a new tolerance band.
- t2 = no storage, since the measurement is again within the tolerance at the end of the storage cycle (10sec).
- t3 = storage and application of a new tolerance band, since the measurement has gone outside the tolerance band at the end of the storage cycle.
- t4 = storage and application of a new tolerance band, since the measurement has gone outside the tolerance band at the end of the storage cycle.
- t5 = storage through “Min. storage cycle” (forced storage) and application of a new tolerance band.
- t6 = no storage, since the measurement is again within the tolerance



Going outside the tolerance band is not necessarily recorded. If the measurements return inside the tolerance band within the storage cycle (t2), then there will be no recording and “Min. storage cycle” is still active.

2.9 Data Storage

Operating principle

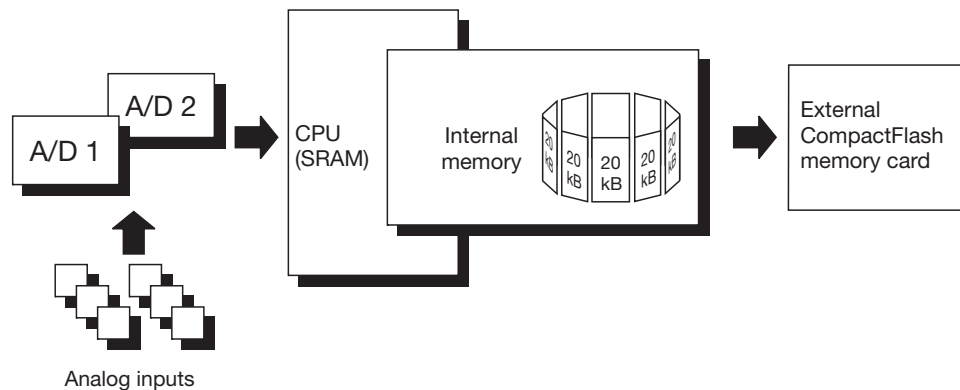

Data recording

Measurements are acquired continuously in a 125msec sampling cycle. Based on these measurements, reports are compiled and limits checked. The measurements are transferred to the main memory of the instrument, according to the programmable storage cycle and stored value (maximum, minimum, average, Min&Max, momentary value or economy mode). The paperless recorder saves the data according to groups, and the input can be assigned to several groups (up to 9).

Main memory (SRAM)

The data stored in the SRAM are regularly copied to the internal memory in 20 kbyte blocks.

Internal memory

When a block in main memory has been filled, it is copied to the internal memory. Internal memory has a capacity of max 256 Mbytes. Every write action is monitored, so that any errors in saving data can be immediately identified. The instrument monitors the capacity of the internal memory and activates one of the “memory alarm” signals when the capacity has fallen below the configurable residual capacity level. These signals can be used, for instance, to operate the alarm relay.

This is written to as a ring memory, i.e. when the memory is full, the oldest data will automatically be overwritten by new data.

The data from the internal memory can be shown as a history presentation on the recorder. The size of the history memory can be configured.

CompactFlash memory card (external)

If an external CompactFlash memory card (Industrial Grade) is inserted into the paperless recorder, memory blocks are automatically written to the CF card.

The instrument monitors the capacity of the CompactFlash card and activates the “Memory alarm (CF card)” signal if the level falls below a configurable residual capacity. This signals can be used, for instance, to operate a relay (warning signal “Swap CF card”).

For recorders with a stainless steel panel (option) the CompactFlash memory card is not available as external memory. The measured data can be saved through one of the interfaces or through a USB flash drive (on the rear side).

2 Instrument Description

| | |
|---|---|
| Data security | <p>The data are stored in coded form in a proprietary format. This ensures a high level of data security. If the CompactFlash card is removed from the instrument, no data will be lost immediately, as these data are still stored in the internal memory. A loss of data will only occur if, after the CompactFlash card has been removed, internal memory is completely rewritten as well, and no data have been read out through the interface.</p> <p>If the paperless recorder is disconnected from the supply, then:</p> <ul style="list-style-type: none">- RAM and clock time are buffered by a lithium battery (ex-factory) for at least ≥ 10 years, with a storage capacitor for at least ≥ 2 days (ambient temperature -40 to +45°C),- Measurement and configuration data in the backup memory will not be lost. |
| Storage cycle | <p>Different storage cycles, ranging from 125msec to 32000sec can be configured for normal, event and timed mode under "Configuration".</p> <p>The storage cycle determines the time intervals at which the measurements are stored.</p> |
| Stored value | <p>Under this parameter, separate configurations are made for normal, event and timed mode, to decide which value is to be stored (average, momentary, minimum, maximum, peak values or Eco mode).</p> |
| Recording format | <p>Data are recorded encoded in a proprietary format.</p> |
| Recording duration | <p>The recording duration depends on various factors:</p> <ul style="list-style-type: none">- number of analog channels and event traces being recorded- Storage cycle (memory rate)- number of events in the event list |
| Optimization of recording duration | <p>The recording duration can be optimized by process-oriented selection of the storage cycle and stored value.</p> <p>In normal operation (no error, no alarm, etc.) a storage cycle that is as long as possible (e.g. 60sec, 180sec, etc.) should be selected, depending on the particular application.</p> <p>In the event of an alarm or error, the storage cycle can be shortened via event mode, with the effect that the measurement data are recorded with a high time resolution.</p> |

2.10 Reading out Data

In addition to automatic read-out via the CompactFlash memory card, measurement data can also be read out through one of the interfaces (RS232, RS485, USB device, Ethernet) and with a memory stick (USB host).

The options for reading a CF card/memory stick and interface work in a parallel manner. For this reason, there are also two “binary signals”, which indicate when the available storage space has fallen below a certain configurable value.

Memory alarm

The limit for alarms can be set by the parameter *Configuration → Device data → Memory alarm* in the configuration level.

The parameter *Configuration → Device data → Data readout via...* can be used to determine which storage space indication should be shown in the status bar. The “binary signals” for storage space detection function independently of this parameter.

Binary Signals

“Mem.al. CF readout”

If this signal is set, this means that no data have been fetched via the CF card or USB memory stick for a prolonged period, and the available capacity of the internal memory has fallen below the configured level (this only applies if the parameter *Configuration → Device data → Data readout via ...* is set to “CF card”).

“Mem.al. interface”

If this signal is set, this means that no data have been fetched via the interface for a prolonged period, and the available capacity of the internal memory has fallen below the configured level (this only applies if the parameter *Configuration → Device data → Data readout via...* is set to “Interface”).

“CF card full”

If this signal is set, it means that not enough space is available on the CF card. The PCA3000 program can help here. Data can be read into PCA3000, and then saved to the hard disk or on a network, thus freeing up space on the CF card. Alternatively, you can use a new CF card.

⇒ See “Binary Signals” on Page 31.



The signal is not operated in reference to a full USB memory stick.

Difference between CF card and USB stick

Unlike CF cards, data are not automatically stored on an inserted USB memory stick.

2 Instrument Description

Readout via interface

Use the PCA Communications software PCC to read out measurement data via the serial or USB device or Ethernet interface.

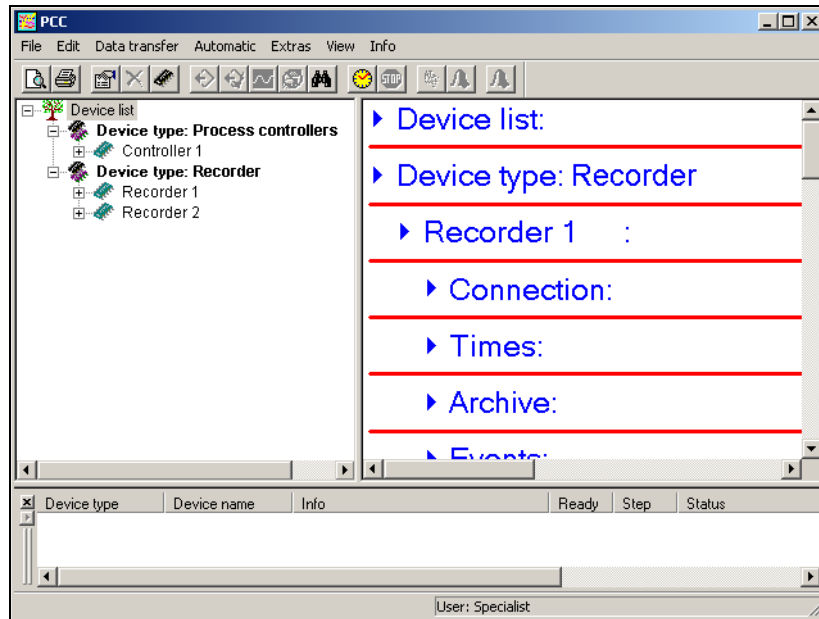

Use the same archive (in the PC) for reading out data via the interface as for a readout via the CF card. This saves having to put together data from different files at a later date.

⇒ Please refer to the Operating Manual 59500 for further information.

2.11 Archiving and Evaluating Data

Life-cycle data management

The integrated life-cycle data management allows users to save all the process data from the system that is being monitored in an archive file on their PCs or a server system.

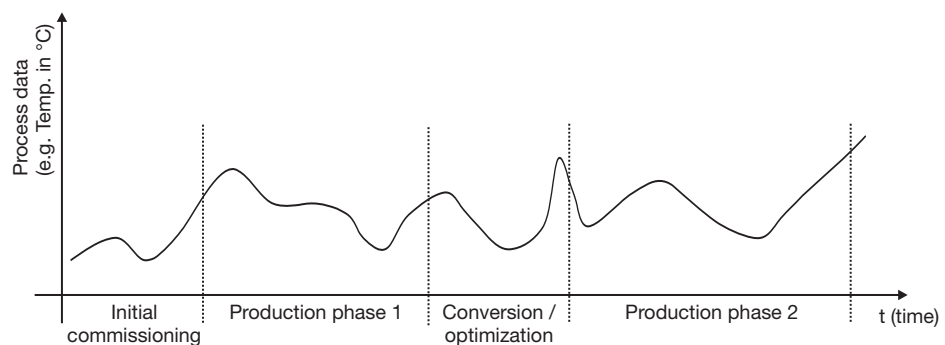

The recovery of configuration-dependent plant/system data, which may be required for commissioning, maintenance or optimization during the life-cycle of a plant or system, is enabled by the associated PC Evaluation software PCA3000 in a dialog window.

2 Instrument Description

Open archive

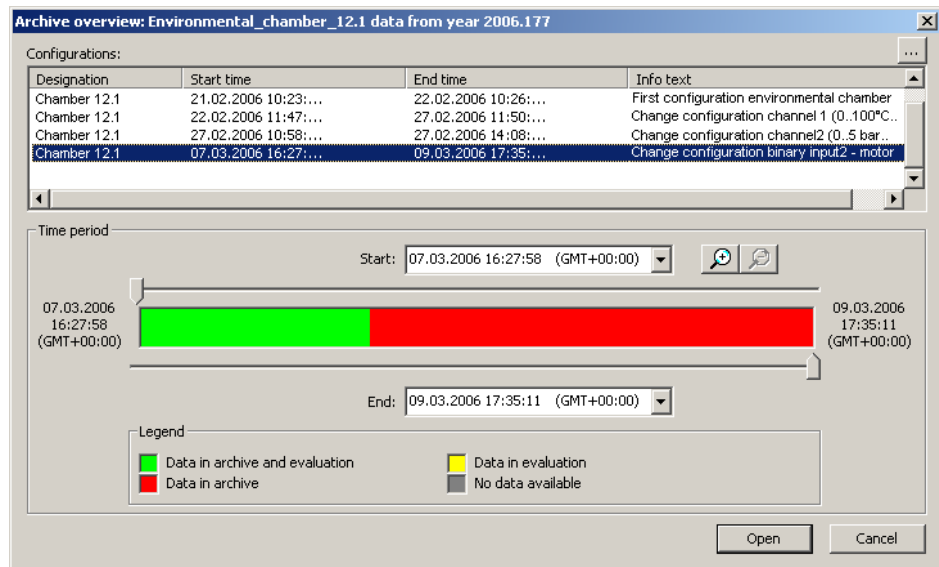

Evaluation software PCA3000

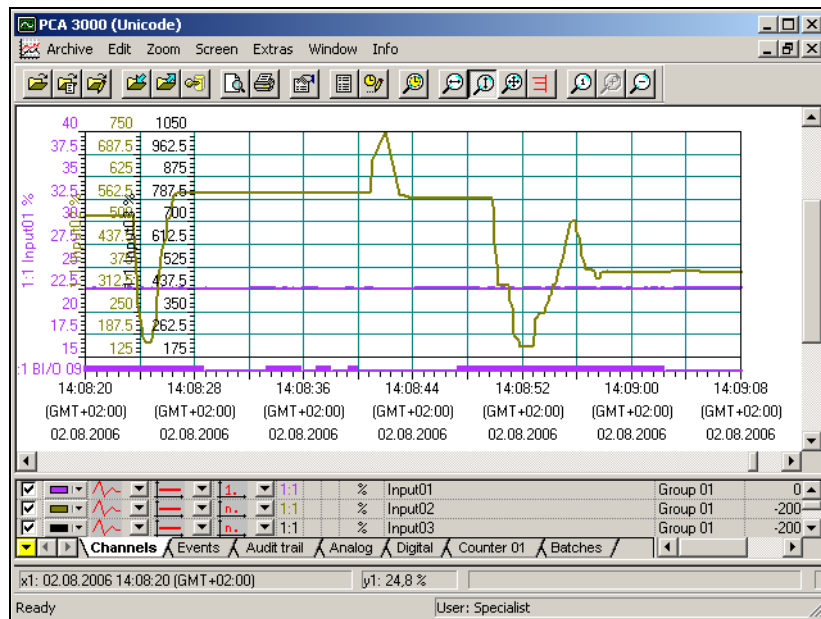

⇒ Please refer to the Operating Manual 59498 for further information.

2 Instrument Description

3.1 Operating Principle and Graphic Elements

Header

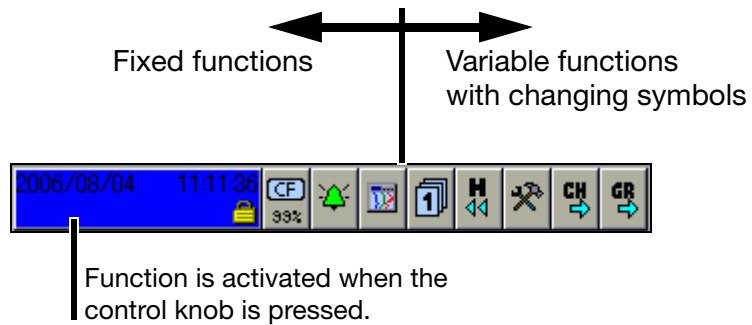

The functions of the paperless recorder are selected in the header. The selected function is indicated by a blue background.

Recorder with control knob



- Function selection by rotating the control knob (to right or left).



- Function is activated by pressing the control knob.

Recorder with touchpad (stainless steel front panel)



- Function selection through a circular motion with a finger at the outer edge of the touchpad (when activating the circular motion, two of the eight LEDs in the touchpad are on).



- Function selection by tapping the middle of the touchpad (all LEDs in the touchpad are on).

The symbols (for the variable functions) vary according to the function that is currently active.

The following diagram shows the header for normal display when the vertical

3 Operating Principle

diagram (curve display) has been selected.

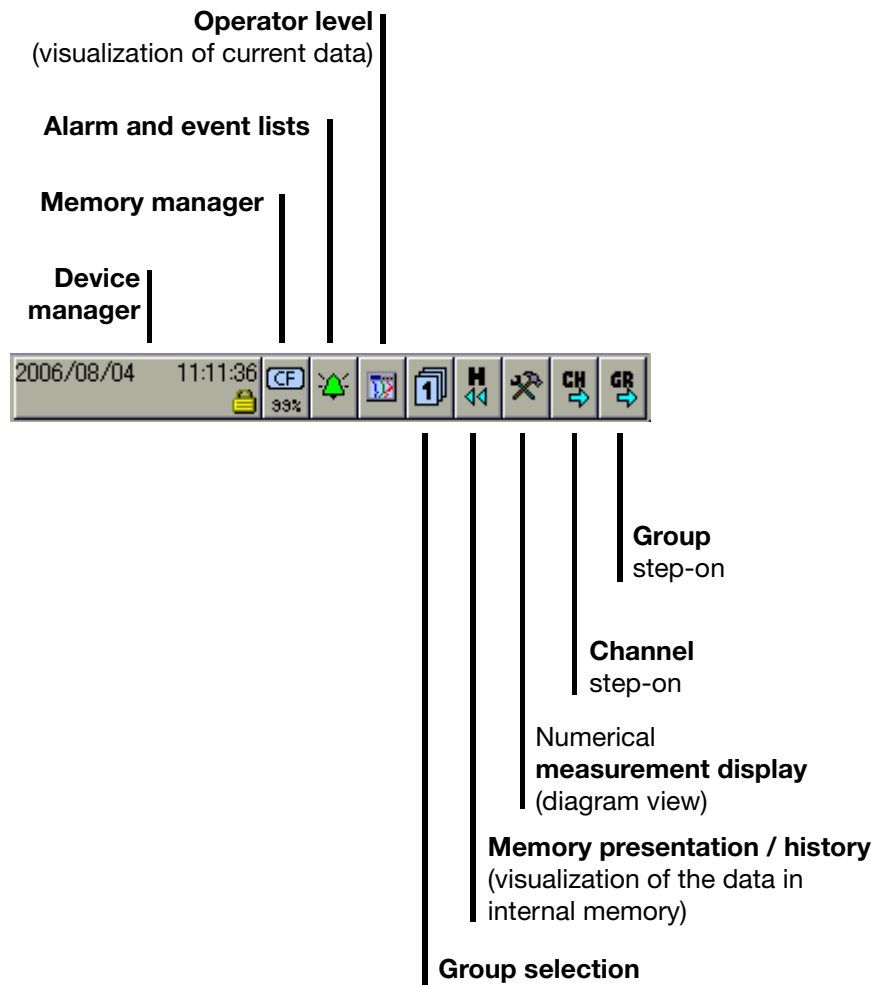

| | |
|--------------------------------|---|
| Device manager | ⇒ Chapter 8 |
| Memory manager | ⇒ Chapter 7 |
| Alarm and event lists | ⇒ Chapter 6 |
| Operator level (visualization) | ⇒ Chapter 4 |
| Group selection | ⇒ See “Group selection” on Page 55. |
| Memory presentation (History) | ⇒ Chapter 5 |
| Numerical measurement display | ⇒ See “Numerical measurement display (diagram view)” on Page 46. ⇒ See “Numerical measurement display” on Page 55. |
| Channel step-on | ⇒ See “Channel step-on” on Page 59. |
| Group step-on | ⇒ See “Group step-on” on Page 59. |

3 Operating Principle

Status and title bar

This line (bar) shows alarm and error messages, as well as general information, and information about the active representation mode (e.g. sampling rate). It is automatically blanked out by the system, if necessary.

If the text is shown in red, this indicates an error message.



Sampling rate and operating mode

5s = normal mode

1s ! = event mode

1s 🕒 = timed mode



Data are currently being read by the PCA Communications software PCC.



Data are currently being transferred to the CF card.

Caution: Do not remove CF card!

3 Operating Principle

Numerical measurement display
(diagram view)

The numerical measurement display is available for the presentation modes:

- Curves,
- history (of the curve presentation) and
- digital diagram

available.

In the **curve presentation**, the numerical display can be switched on or off. This switching on or off also applies to the history presentation.



An alarm for a channel is shown in red (HIGH alarm) or orange (LOW alarm). The colors can be configured in the setup program.

If the numerical measurement display is switched on in the **history (of the curve presentation)**, you can switch between MIN and MAX display. Whether or not MIN and MAX values are both available at the same time, depends on the settings for the group operating mode.



In the **digital presentation**, the diagram header can be switched on and off.





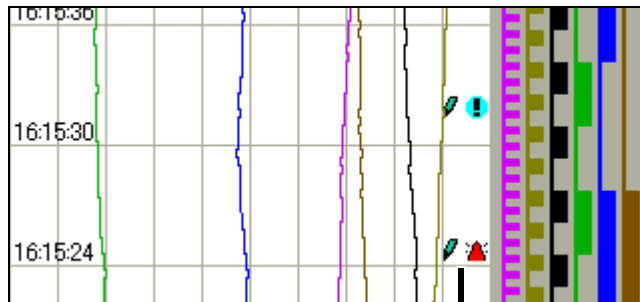

3 Operating Principle

Visualization window (diagram)



Symbols for data acquisition:

-  Comment has been entered
-  Event occurred
-  Alarm is no longer present
-  Alarm has been signaled

In the visualization window, the measurement data are shown in graphical form. Alarms are indicated by a red or orange color for the curve (can be configured in the setup program).

Communication with the operator (device configuration, checking alarm and event lists etc.) also takes place via the visualization window.

3 Operating Principle

3.2 Operating Example

Start The normal display is active.

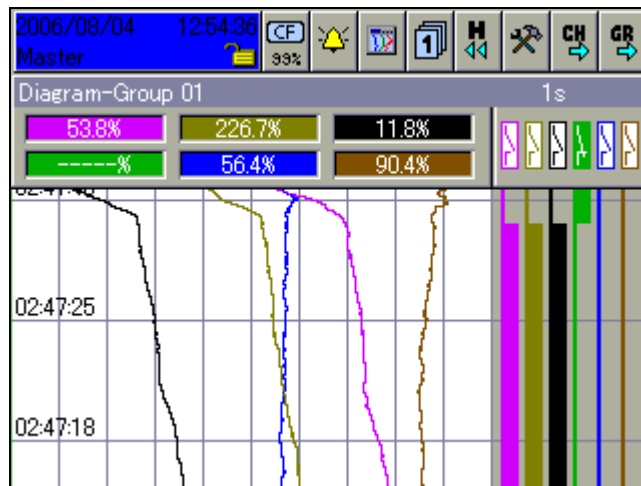

Operation



* Select the operator level by rotating the control knob.



* Activate the operator level by pressing the control knob.

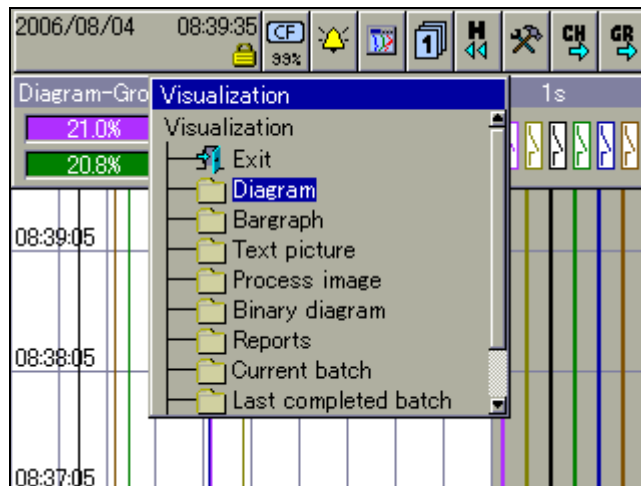

3 Operating Principle



* Select the operator level by rotating the control knob.

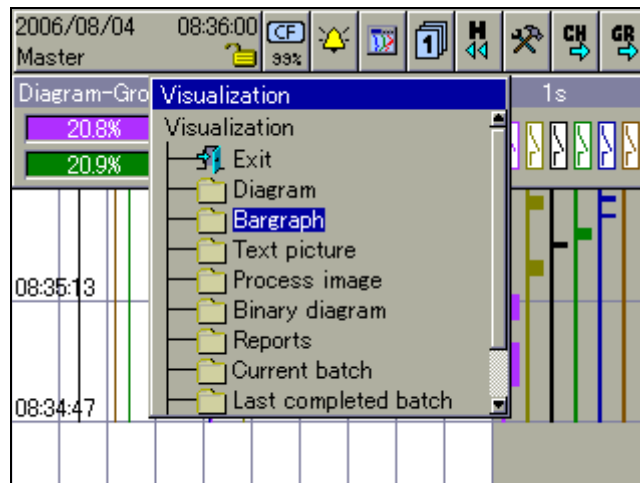

* Activate the bar graph presentation by pressing the control knob.

Result

The bar graph presentation starts.

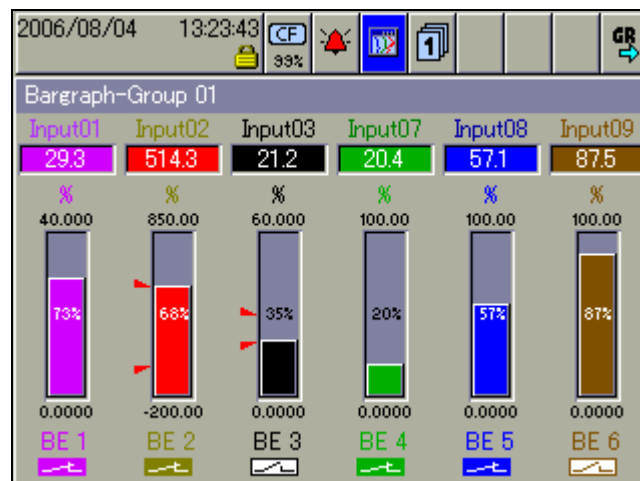

3 Operating Principle

3.3 Group and Plant Management (Batches)

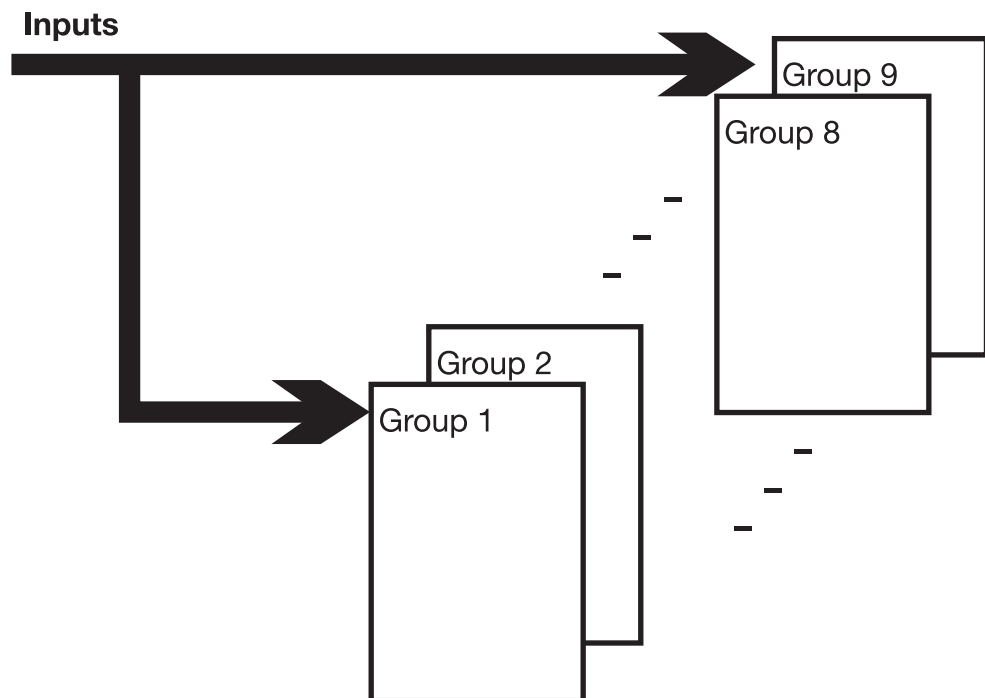

Within the recorder, all analog inputs, binary inputs, counters and integrators, are collected together into groups. A maximum of nine groups is available as a total. Each group can consist of a maximum of 6 analog inputs, 6 binary inputs (or outputs), and 4 counters/integrators.

The visualization and storage of the analog inputs and binary inputs (outputs) is always made on a group basis.

If plants (batches) are used, the groups have fixed assignments to the plants (batches).

| Plant number | Group | Plant (batch) |
|--------------|-------------------------------|------------------------|
| 0 | 1 ... 9 | None |
| 1 | 1 ... 9 | 1 |
| 2 | 1 ... 3 4 ... 6 7 ... 9 | 1 2 Not assigned |
| 3 | 1 ... 3 4 ... 6 7 ... 9 | 1 2 3 |

3 Operating Principle



In order for a batch to be usable, its main group must be active (status = “Display” or “Display, save”) and at least one analog channel in the group must be assigned.

| Batch for plant | Main group |
|-----------------|------------|
| 1 | 1 |
| 2 | 4 |
| 3 | 7 |

The number of plants is configured through the parameter *Device manager* → *Configuration* → *Batches/plants* → *Gen. plant parameters* → *Number of plants*.

3 Operating Principle

4.1 Activating the Operator Level

The type of visualization (curve presentation, bar graph etc.) is selected at the operator level. Note that the appearance of the operator level can be influenced by the configuration.

- * Select the operator level by rotating the control knob.
- * Activate the operator level by pressing the control knob.



Operator level

You can alter the visualization after activating the operator level.

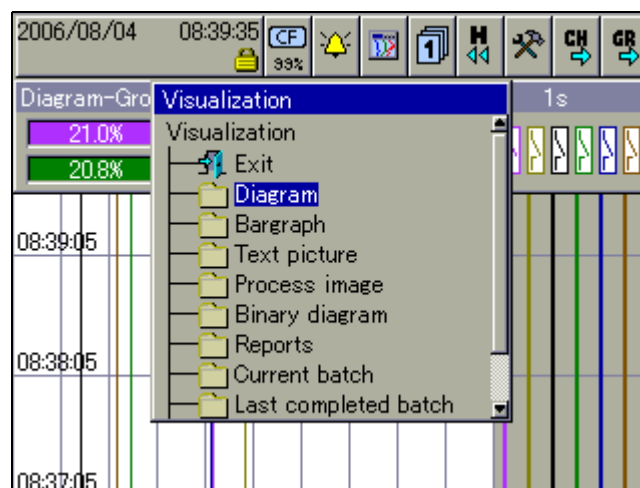

The functions in the header line will change, depending on the visualization. The following types of visualization are available:

| | |
|----------------------|----------------|
| Curves | ⇒ Chapter 4.3 |
| Bar graph | ⇒ Chapter 4.4 |
| Text picture | ⇒ Chapter 4.5 |
| Process image | ⇒ Chapter 4.6 |
| Binary | ⇒ Chapter 4.7 |
| Report | ⇒ Chapter 4.8 |
| Batch | ⇒ Chapter 4.9 |
| Counters/integrators | ⇒ Chapter 4.10 |
| Comment entry | ⇒ Chapter 4.11 |

4 Visualization

4.2 Overview of Header Lines

| | |
|-------------------------------------|--|
| Curve presentation (diagram) | |
| Bar graph presentation | |
| Text picture presentation | |
| Process image presentation | |
| Digital presentation | |
| Reports | |
| Batches (current) | |
| Batches (completed) | |
| Counters and integrators | |

Comment entry The comment entry does not have its own header. The current header will remain when this function is activated. The comment that has been entered is placed in the event list.



The first four functions in the header are identical for all visualizations. These are supervisory functions (see “Header” on page 43).

Differences only arise in the last five functions.

4.3 Curve Presentation

In this presentation, the individual signal traces run from top to bottom of the display (vertical presentation).

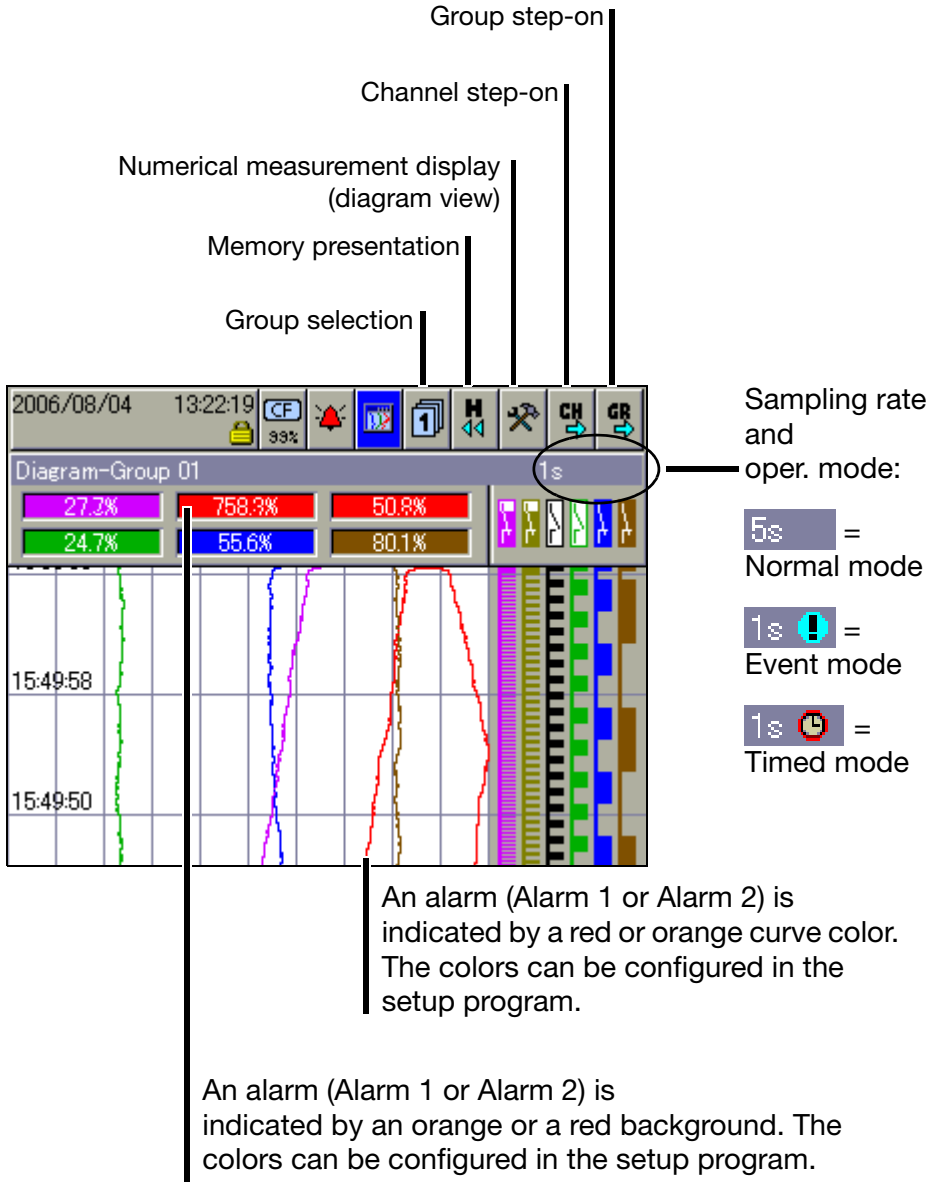

- Group selection** You can use this function to directly select and display any one of the groups.
- Memory presentation** This function starts the presentation of the data that are available in the history memory.
⇒ Chapter 5 "Memory Presentation (History)"
- Numerical measurement display** This function is used to switch the numerical measurement display (diagram header) and binary traces on or off, as well as to activate the envelope display.

4 Visualization

Channel step-on

This function activates the scaling display. Repeated activation steps through the scaling for the channels within the group, and then blanks it out again.

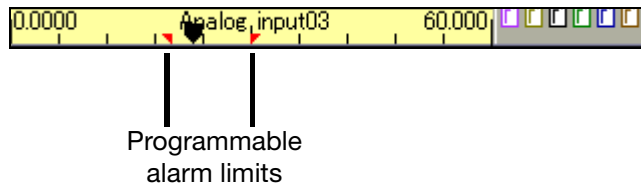

Group step-on

Unlike "Group selection", where any group can be selected, this function is used to select the groups one after another.

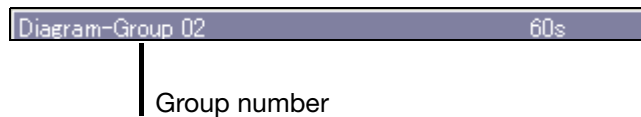

4.4 Bar Graph Presentation

In this visualization mode, the analog inputs are presented both numerically and in bar graph form. In addition to the analog channels, the digital inputs can also be visualized at the bottom of the display.

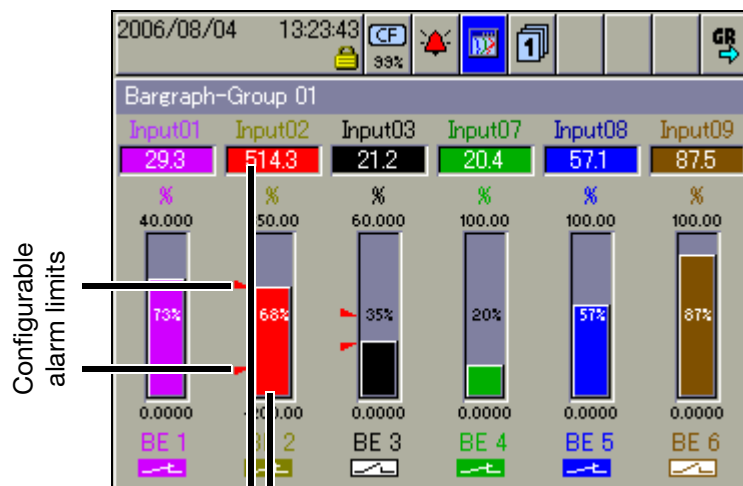

An alarm (Alarm 1 or Alarm 2) is indicated by an orange or red background. The colors can be configured in the setup program.

If only digital channels are to be presented, then Chapter 4.7 "Binary diagram presentation" is recommended.

4.5 Text Picture Presentation

In the presentation, the analog channels are presented numerically, together with the channel name and the channel description. In addition to the analog channels, the digital inputs can also be visualized at the right-hand edge of the display.

Group presentation

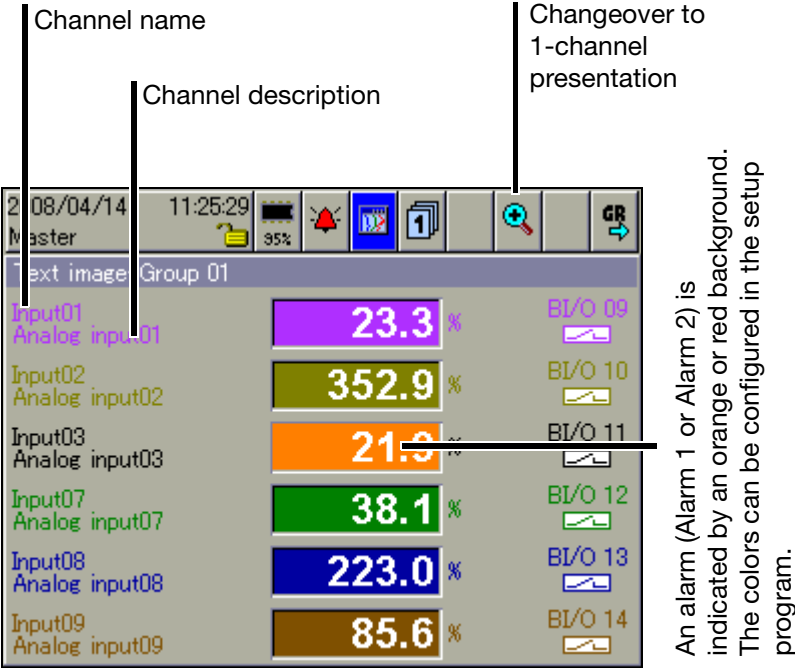

1-channel presentation

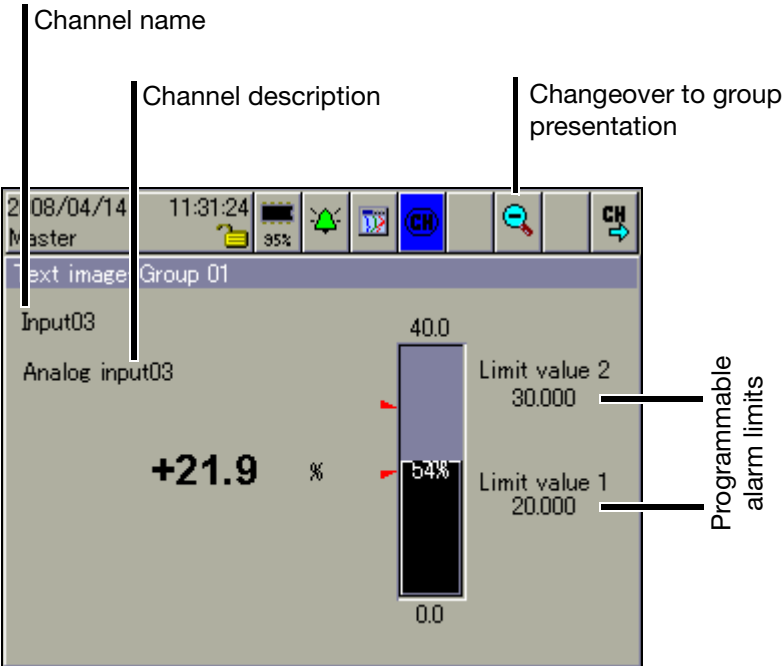

4 Visualization

4.6 Process Image Presentation

The display shows selected measurement signals and background pictures in a maximum of nine process images. The setup program is used to prepare and configure the images.

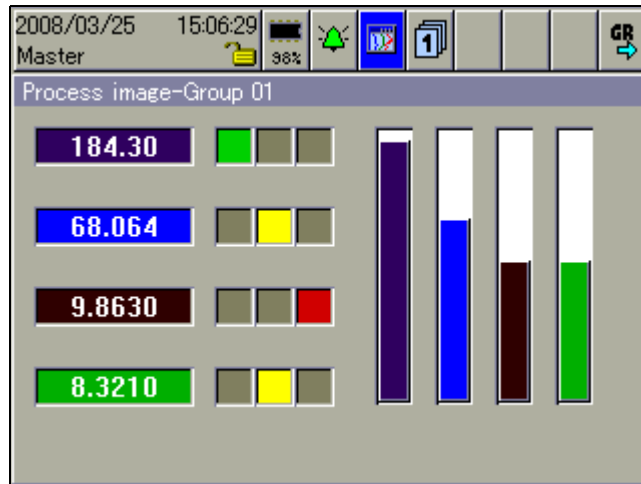

Each process image can be freely configured by the user. One background image (316 × 188 pixel) and 25 objects (analog/binary signals, icons, texts, bars) can be used per process image. Further information can be obtained from the instructions on the setup program (59492).

4.7 Binary diagram presentation

In this presentation, the analog channels are left out and only the binary channels and signals are visualized.

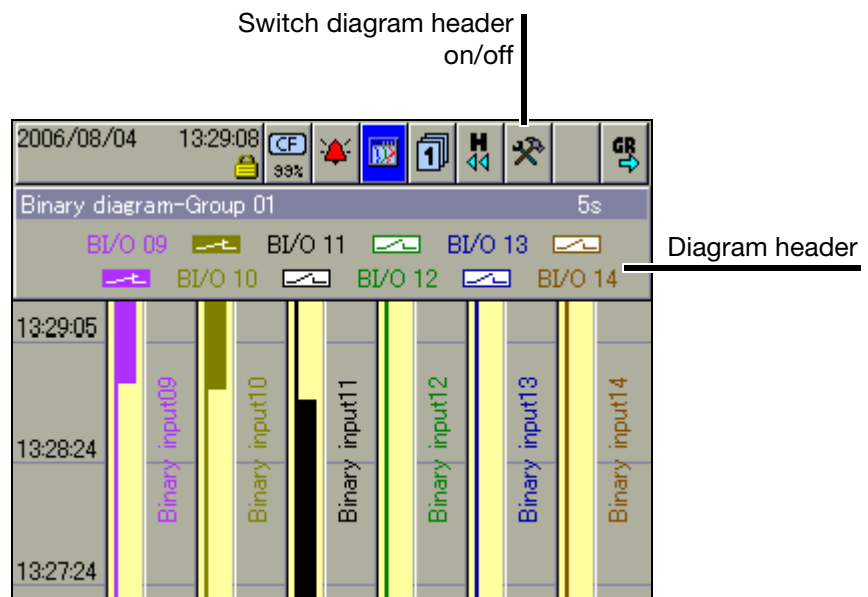

4.8 Reports

Each one of the reports covers all the analog channels in a group. Each group has its own configurable report.

The current reports are visualized in the presentation.

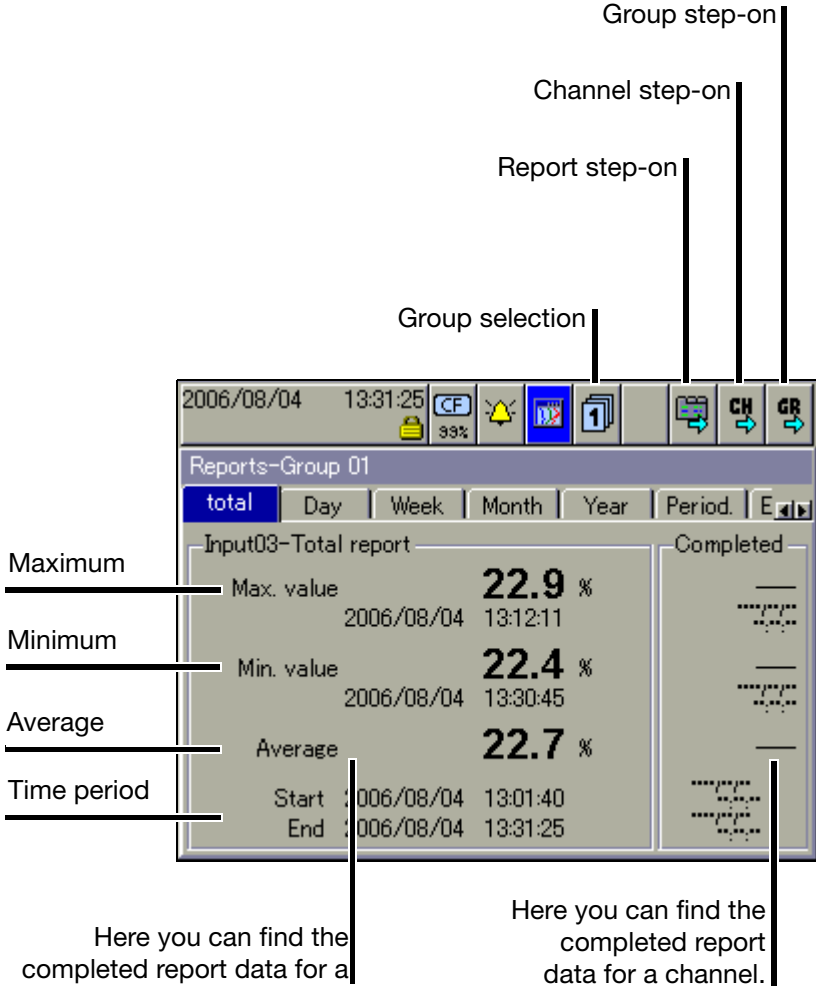

- Group selection** You can use this function to directly select any one of the groups and display the report data.
- Report step-on** This function is used to switch between the various types of report for the current channel.
- Channel step-on** This function can be used to switch between the individual channels of the group that is currently active.
- Group step-on** Unlike “Group selection”, where any group can be selected, this function is used to select groups one after another.

4 Visualization

4.9 Batches/Plants

When recording batch processes, a distinction is made between the plant and the batch.

The instrument can combine and record the data from up to 3 plants in batches (batch report). The number of batches for a plant is not limited. The instrument distinguishes between “current batch” and the most recently “completed batch” for a plant. The number of plants that are used and the texts in the batch template can be configured on the instrument or in the setup program.

4.9.1 Current Batches

⇒ This display shows the current data for the batch(es). Further information about entering the texts in the left and right columns can be found in Chapter 23 "Configuration – Batches/Plants".

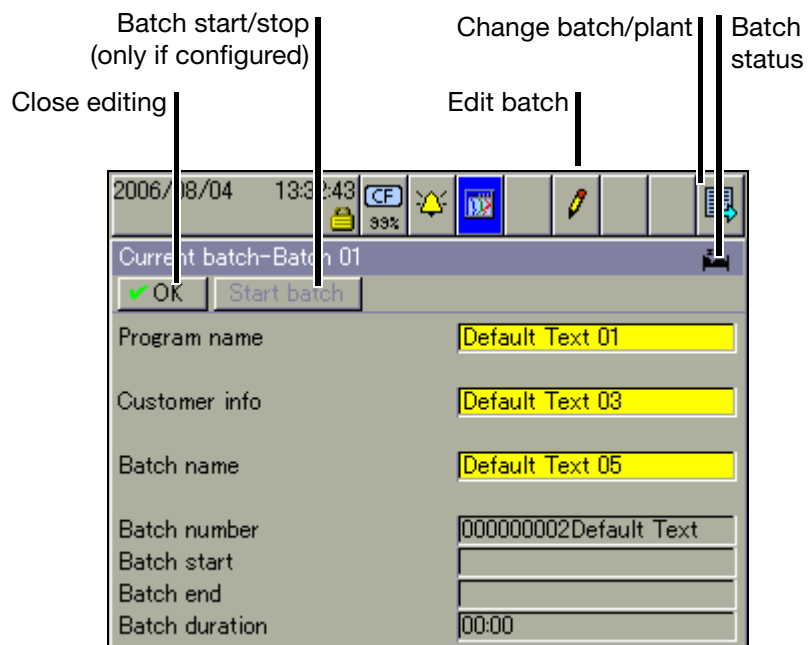

The batch texts on the right-hand side can be entered with one of the following options:

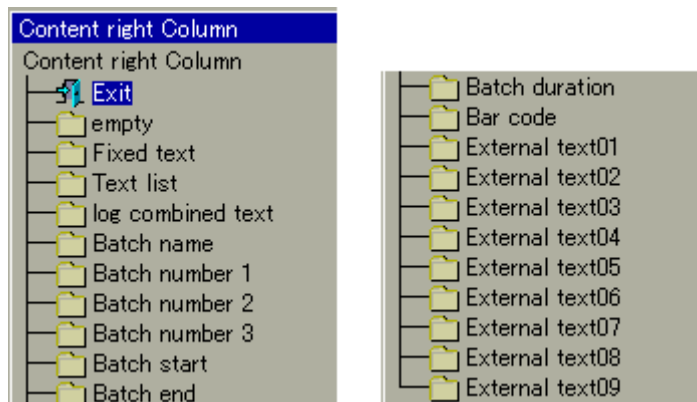

Edit batch

This function can be used to edit the batch text fields that are available (configured for this purpose). When the function has been called up, the first editable field in the screen template will be activated.



- * Press the control knob to start editing.
- * Enter the text (Chapter 26 "Entering text and values").



- * Rotate the control knob to select a new field or button, and activate it by pressing the control knob.

Change batch/ plant

Switching between the individual batches/plants. Max. 3 plants can be configured.

Start/stop batch

Use the parameter *Device manager* → *Configuration* → *Batches/plants* → *Plant X* → *General* → *Batch start* to configure how a batch starts and stops. The following are available:

- Start/stop by a binary signal (control signal)
- Start/stop by a barcode reader, and
- Manual start/stop by control knob.



At least 5 seconds must elapse between the stop of a batch (batch end) and the next start (batch start). A new batch cannot be started until this time has elapsed.

Batch status



The batch report that is displayed is active.



The batch report that is displayed is **not** active.

4 Visualization

4.9.2 Completed Batches

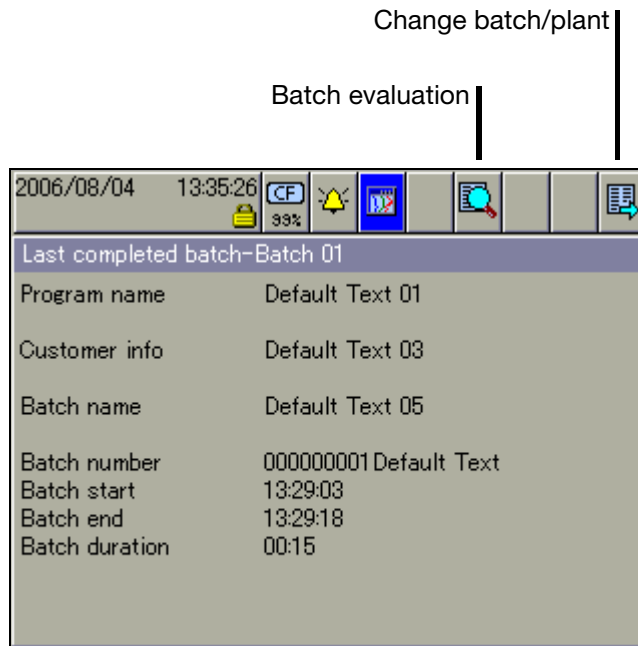

Batch evaluation

Completed batches can be evaluated in three different ways:

- Curves (graphical presentation)
- Report (numerical presentation)
- Attachments (e.g. recipes)

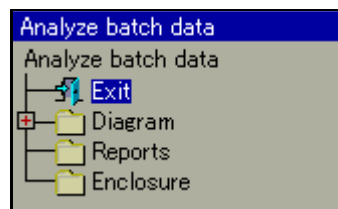

- * Rotate the control knob to select a type of presentation, then press the knob to activate this type.



Activating the door symbol in the header closes the selected presentation, and the batch data will be displayed again.

Change batch/plant

The corresponding batch data will be shown in its own batch visualization, depending on how many plants have been configured.

4.9.3 Batch Control with Barcode Reader

If a barcode reader is connected to the interface “RS232 for barcode reader” (connector 2) or “RS232/RS485” (connector 7), then the batch start, batch stop, and input of batch texts in a current batch report, can be controlled by the barcode reader. The bar codes that are used all correspond to the type “Code39”.

Preconditions

- The interface must be configured for bar code operation.
Example:
Configuration → Interface → RS232 for barcode reader → General → Protocol = bar code.
- The batch start (= batch stop) must be configured.
Example for batch start/stop:
Configuration → Batch/plant → Batch (Plant) 1 → General → Batch start = bar code.
- Every line that is to be set by the bar code must be configured.
Example for plant 1, line 1 (program name):
Configuration → Batch/plant → Batch (Plant) 1 → Line 1 → Content of right column = bar code.

Activate batch



Before entering commands through a barcode reader, the corresponding batch/plant 1 — 3 must be prepared by scanning in “BATCH1 — 3” for the bar code commands, regardless of whether or not they are automatically displayed.

Show batch report

If one of the visualizations is active, and nothing is being entered or edited at the moment, then the current batch report can be inserted via the barcode reader. The precondition is that the batch is active and the parameter is set to *Configuration → Screen → Bar code -> current batch = Yes.*

Activate and display (if required) batch report for batch (plant) 1:



BATCH1

Activate and display (if required) batch report for batch (plant) 2:



BATCH2

4 Visualization

Activate and display (if required) batch report for batch (plant) 3:



Start and stop batch report

If the batch report is configured for start/stop via barcode reader, then it will be started and stopped as follows.

Start batch:

- * Scan bar code for “Batch report for batch (plant) 1 – 3”.
- * Scan start.



Stop batch:

- * Scan bar code for “Batch report for batch (plant) 1 – 3”.
- * Scan stop.



If a batch report is stopped, then texts that have been activated by a bar code will be reset to the standard text in the currently active batch report depending on the parameter "Delete line". In the completed batch report, the texts will be saved.

⇒ See “Delete line” on page 170.

Activate batch texts

If a line in a batch report is configured for barcode activation, the activation proceeds as follows.

Activate text:

* Scan bar code for "Batch report for batch (plant) 1 – 3".

Scan text.



The first line of the activated batch report that has been configured for text input via bar code will automatically be filled with the text that corresponds to the bar code. If several line have been configured for barcode activation, then they will be processed one after another, from top to bottom.

Reset entry

Execution of the following bar code will reset the activation of the batch texts. The standard texts (parameter *Factory setting*) will be displayed, and the first line will be prepared for input.



Summary of the bar codes

All the bar codes that are required are also collected together in Chapter 28.1 "Bar code".



The codes for batch control (BATCH1, BATCH2, BATCH3, START, STOP, RESET) cannot be used for setting batch texts.

4 Visualization

4.10 Counters and Integrators

In this presentation, the current states of the counters and integrators (totalizers) are displayed, as well as the operating hours counter. Up to 9 counters and integrators can be shown in one screen template. The functional characteristics (counter, integrator or operating hours counter) are defined in the device configuration.

Overview presentation

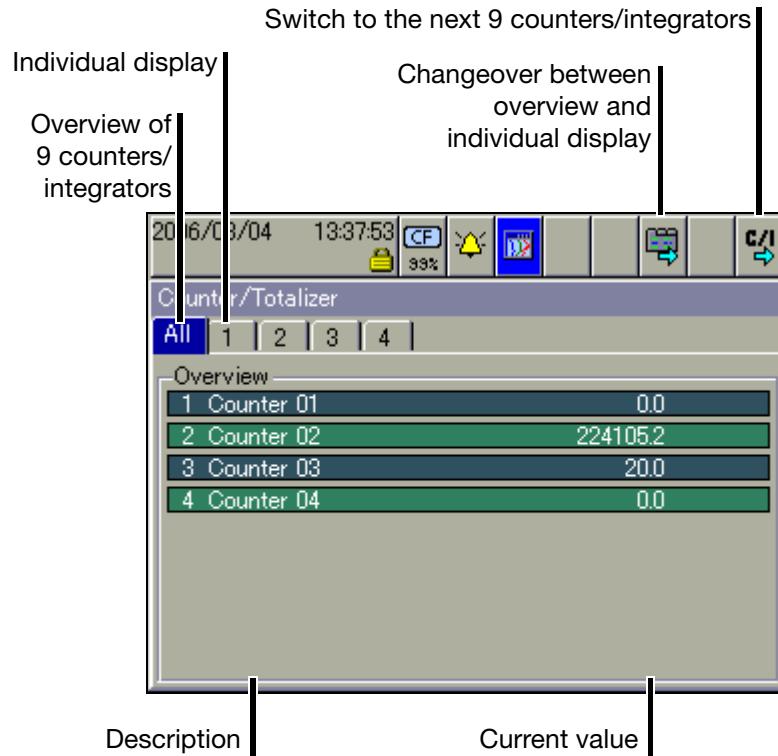

Individual presentation

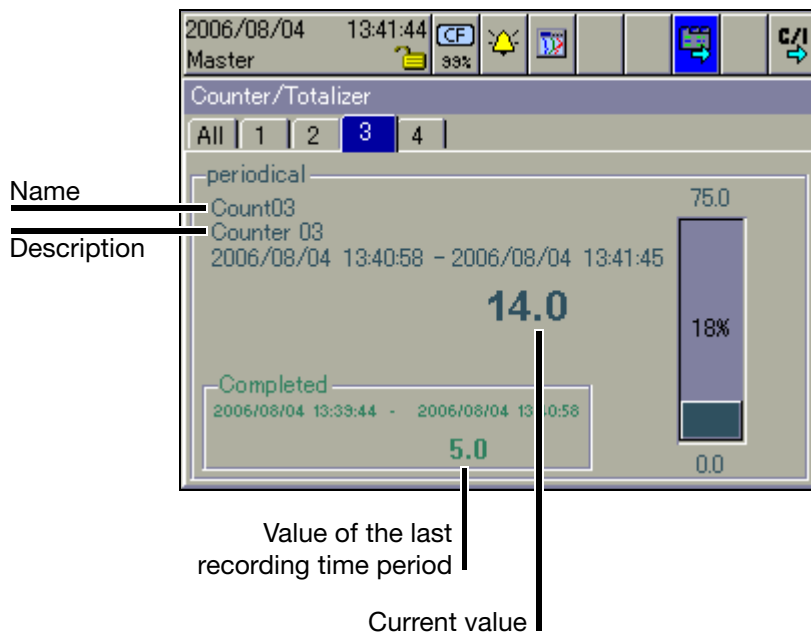

4.11 Comment Entry

This function can be used to enter a text (max. length 31 characters) that is entered in the event list when the input is completed.

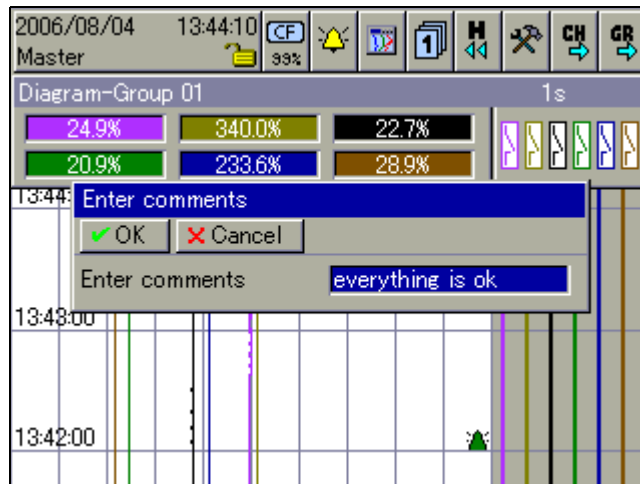

In curve presentation (in the displayed group), the text entry is marked by a pencil symbol.



- ⇒ Chapter 6 "Alarm and Event Lists"
- ⇒ Chapter 4.3 "Curve Presentation"
- ⇒ Chapter 4.11 "Comment Entry"

The text can now be found in the event list, under the heading "All events", but also under the corresponding batch.



If batches are used (parameter: *Device manager* → *Configuration* → *Batches/plants* → *Gen. plant parameters* → *Number of plants* is larger than 0), then the groups have a fixed assignment to the batches.

| Plant number | Group | Plant (batch) |
|--------------|-------------------------------|------------------------|
| 0 | 1 ... 9 | None |
| 1 | 1 ... 9 | 1 |
| 2 | 1 ... 3 4 ... 6 7 ... 9 | 1 2 Not assigned |
| 3 | 1 ... 3 4 ... 6 7 ... 9 | 1 2 3 |

4 Visualization

5 Memory Presentation (History)

The Memory presentation function can be used to display and check data from the internal main memory (SRAM) of the instrument. The size of the memory for memory presentation can be configured.

The memory presentation can be activated in the visualization modes “Curve presentation” and “Binary presentation”, and is also used to display completed batches.



The memory presentation can only be called up if the parameter *Configuration* → *Groups* → *Group x* → *Parameters* → *Status* is set to “Display, save” in the configuration for the group.

Activate memory presentation (History)



- * In “Curve presentation” or “Digital presentation”, rotate and press the “H” symbol to select and activate the History presentation.

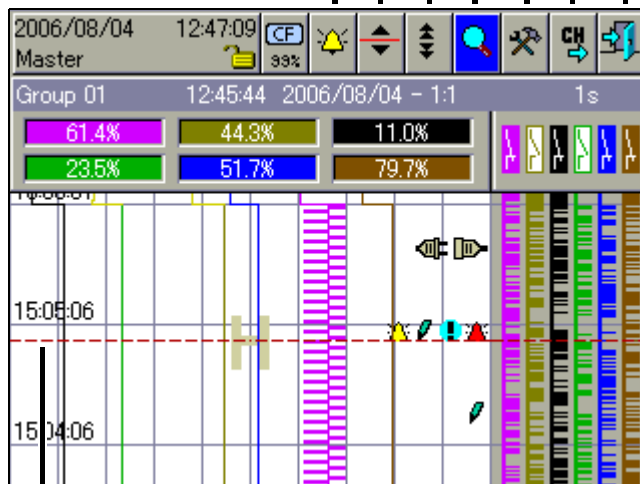
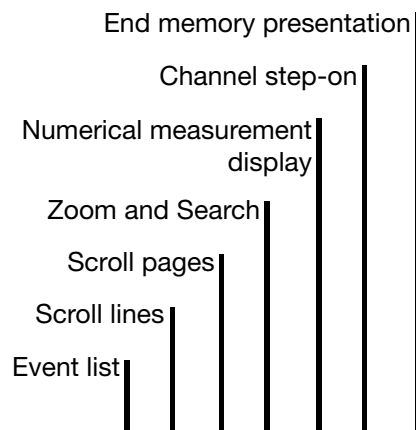

Present cursor position

A cursor is now shown in the center of the visualization window. The corresponding measurements are shown in the line for “Numerical measurement display”. The status and title bar shows the time corresponding to the present cursor position, storage cycle that was used, and the scaling for the presentation.

5 Memory Presentation (History)

Event list This function is used to present the event list for the group that is visible. The message that is closest to the cursor is shown in the list.

⇒ Chapter 6 "Alarm and Event Lists"

Scroll lines Rotating the control knob moves the cursor through the visualization window. The data in the "Numerical measurement display" are updated every time there is a shift. If you move right up to the edge of the window, the measurement curve will automatically be shifted and the required data will be presented.

"Scroll lines" can be ended by pressing the control knob.

Scroll pages Rotating the control knob moves the cursor an entire screen (=page) at a time. The data in the "Numerical measurement display" are updated every time there is a shift. The system automatically positions the cursor at the end of the page, as required.

"Scroll pages" can be ended by pressing the control knob.

Zoom and search This function affects how many measurements are used to calculate a point in the diagram, and to search for measurements according to date and time.

Zoom

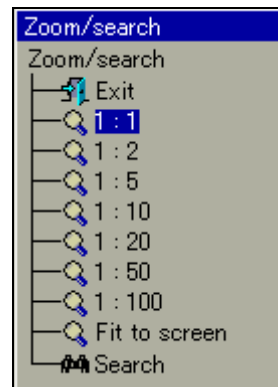

The factory setting is "1:1", which means that every measurement in the History memory will be displayed. "1:2" means that every second measurements is displayed, and so on.

- * Select the zoom factor by rotating the control knob.
- * Close the dialog window and activate the new zoom factor by pressing the control knob.
- * Selecting "Exit" closes the dialog window, and the presentation remains unchanged.

Fit to screen

This function is only available for presenting the data for a completed batch. If this function is selected, the zoom factor will automatically be adjusted so that the measurement curve for the completed batch is shown in one window. However, 1:1 presentation should be used for evaluating a batch.

5 Memory Presentation (History)

Search

If you select “Search”, the dialog window for entering the date will be shown.

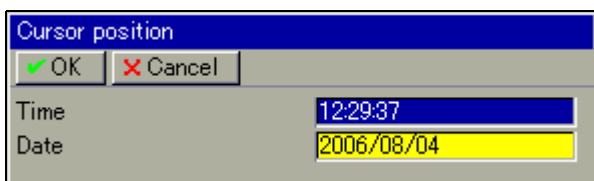

* Select the date and time, and use OK to close the dialog.

If the date that was entered is in the History memory, the cursor will move to this position and the data will be shown.

Numerical measurement display

This function decides whether the MAX or MIN values are shown in the “Numerical measurement display”. Min or Max values arise when more measurements are recorded than are displayed. This will be the case if “Min/Max recording” is activated in a group operating mode.

Channel step-on

This function activates the scaling display. Repeatedly activating the function steps through the scaling for the channels within the group, and then blanks it out again.

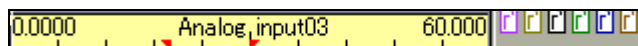

Close memory presentation

This function starts the presentation of the data that are available in the internal main memory of the instrument.

5 Memory Presentation (History)

6 Alarm and Event Lists

The alarm and event lists can be called up in two ways:

- A call from one of the visualization modes, e.g. curve presentation (diagram)
(Chapter 4.2 "Overview of Header Lines")

and

- A call from the memory presentation
(Chapter 5 "Memory Presentation (History)").

Alarm lists

Alarm lists contain only the alarms and errors that are currently present.



The alarm list will not be updated as long as the window is open.
Remedy: Close once, and open again. This will update the alarms.

Event lists

Events list contain all the events that have occurred, including all alarms and errors.



A maximum of 150 entries can be fitted into the two lists. The lists will be deleted if a reconfiguration takes place.



The following description assumes that three batches are being used. The number of batches may vary, because it can be configured by the user.

6 Alarm and Event Lists

6.1 Call from One of the Visualization Modes

- * In the header line, rotate and press the control knob to select and activate the bell symbol.



- * Select the required list.

Activate alarm list

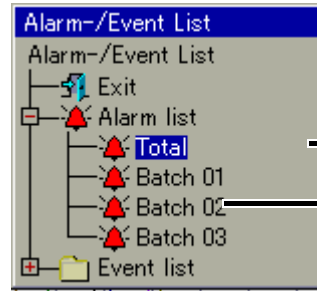

Complete list of alarms

Batch-related alarm lists if the number of batches is reduced, then fewer entries will be displayed.

- * Rotate the control knob to select a list, then press the knob to activate the list.

Activate event list

First, the directory tree for the event lists must be “unfolded”.

- * Rotate the control knob to select an event list, then press the knob to activate the list.

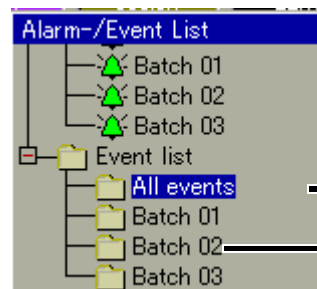
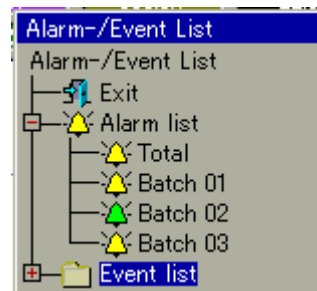

Complete list of events

Batch-related event lists

6 Alarm and Event Lists

- * Rotate the control knob to select a list, then press the knob to activate the list.

Example

In the example, you can see a complete event list.

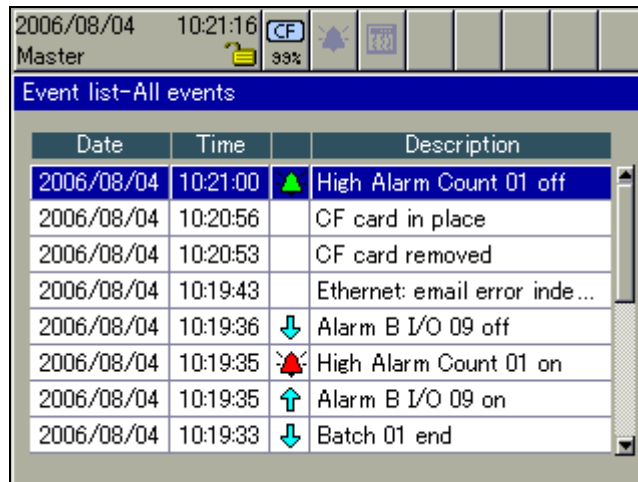

The screenshot shows a control panel interface. At the top, it displays the date and time '2006/08/04 10:21:16' and the status 'Master'. Below this is a status bar with 'CF 33%' and several icons. The main display area is titled 'Event list-All events' and contains a table with the following data:

| Date | Time | | Description |
|------------|----------|---|-------------------------------|
| 2006/08/04 | 10:21:00 | ▲ | High Alarm Count 01 off |
| 2006/08/04 | 10:20:56 | | CF card in place |
| 2006/08/04 | 10:20:53 | | CF card removed |
| 2006/08/04 | 10:19:43 | | Ethernet: email error inde... |
| 2006/08/04 | 10:19:36 | ▼ | Alarm B I/O 09 off |
| 2006/08/04 | 10:19:35 | ▲ | High Alarm Count 01 on |
| 2006/08/04 | 10:19:35 | ▲ | Alarm B I/O 09 on |
| 2006/08/04 | 10:19:33 | ▼ | Batch 01 end |

Close list

- * Close the event list by pressing the control knob.

The visualization that was active before the list was called up will now be displayed again.

6 Alarm and Event Lists

6.2 Call from the Memory Presentation



- * In the header line, rotate and press the the control knob to select and activate the bell symbol.



Only the event list for the active group will be shown in the memory presentation. The message that is closest to the cursor is shown in the list.

Close list

- * Close the event list by pressing the control knob.

The memory presentation that was active before the list was called up will now be displayed again.

6.3 Symbols

| | |
|-------------|--|
| | Power on (instrument has been switched on) |
| | Power off (instrument has been switched off) |
| | Error |
| | Alarm disappears (alarm is no longer present) |
| | Alarm occurs (an alarm is present) |
| | Comment |
| | Event occurs (e.g. binary input has been closed) |
| | Event disappears (e.g. binary input has been opened) |
| (no symbol) | Other messages |

7 Memory Manager

The memory manager contains functions for data exchange between the paperless recorder and CF memory cards or USB memory sticks.



Symbols

The symbol for the Memory manager (menu: Memory manager) in the header can be shown in different ways.



This shows the available memory of the CompactFlash memory card that has been inserted.



Shows the available memory of the USB memory stick.

If no CF card or no USB memory card has been inserted, then one of the following symbols will be shown, depending on the type of data read-out that was configured.



This shows the available internal memory for reading out data via the CompactFlash memory card.



This shows the available internal memory for reading out data via the interface.

Activation for CF cards



Access to the memory manager menu via the header is only possible if a CF card is inserted in the device.

If one of the visualization modes, (see Chapter 4 - e.g. Curve Presentation), is active when a CF card is inserted in the instrument, then the menu appears automatically.

If not all functions are available, then you must log in to the device first, in order to obtain the required access rights.

⇒ Chapter 8.2 "Log-in and Log-out"



The CF card must not be removed while a data transfer to or from the card is in progress.



If this symbol appears in the status and title bar, do **not** remove the CF card!

7 Memory Manager

Activation for USB stick



Access to the Memory manager menu via the header is **not** possible with a USB memory stick.

If one of the visualization modes (Chapter 4 - e.g. Curve Presentation) is active when a USB memory stick is inserted, the menu automatically appears and remains active until the memory stick is removed again.

If not all functions are available, then you must log in to the device first, in order to obtain the required access rights.

⇒ Chapter 8.2 "Log-in and Log-out"



The USB memory card must not be removed while a data transfer to or from the stick is in progress.

Start via menu

- * Activate the memory manager by rotating and pressing the control knob (CF card must be inserted).

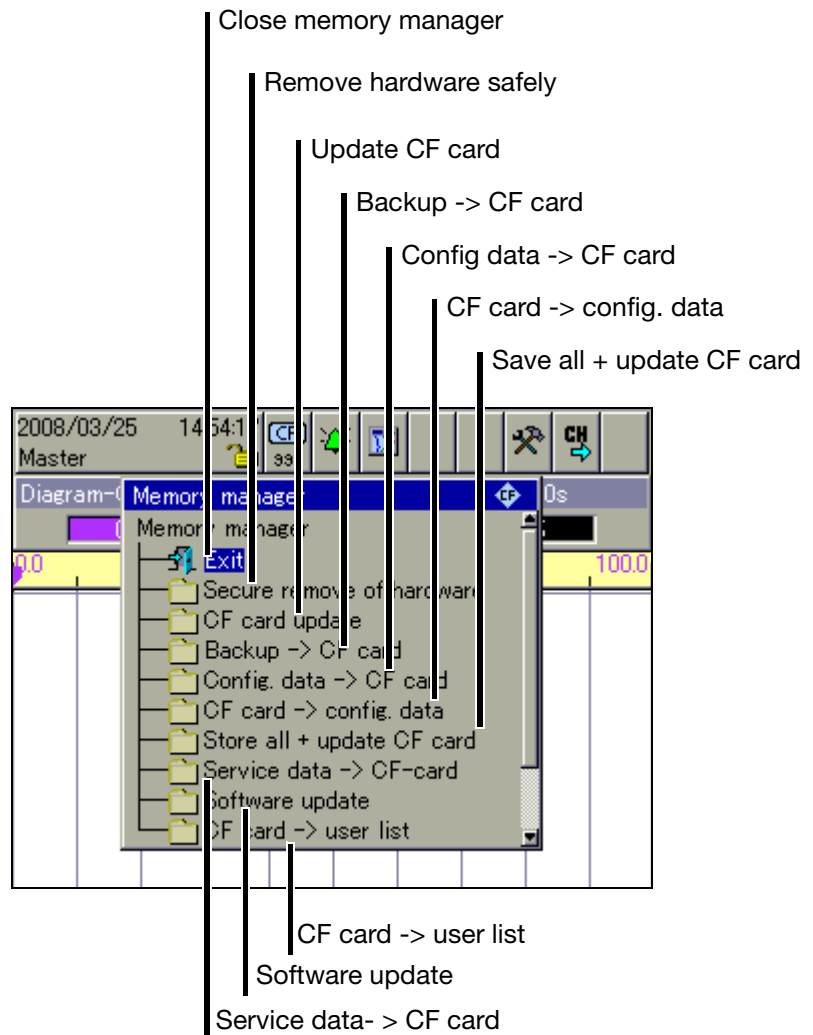

7 Memory Manager



The functions of the memory manager are the same for CF cards and USB memory sticks. For USB sticks, the menu entries have "USB stick" instead of "CF card".

Close memory manager (Exit)

Close the memory manager and reactivate the previous visualization.

Safely removing hardware

The function should always be called before removing a CF card or a USB stick. This is the only way to ensure that files are properly stored on the data storage medium.

When the message "Hardware can be removed now" appears, the data storage medium can be removed.

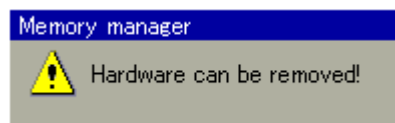

Update CF card

Measurement data not yet saved to a CF card (a USB stick) are written to the data storage medium.

Backup -> CF card

All measurement data in the memory (also those which have already been fetched) are written to the data storage medium.

Config data -> CF card

The configuration data and the user list (for password management) are written to the data storage medium.

CF card -> config. data

Configuration data are read into the device from the data storage medium.



This will give the recorder a new configuration.

Subsequently, the data recording will be started again.

Save all + update CF card

All current reports will be concluded and written to the data storage medium, together with the measurement data that have not yet been saved. The present counter and integrator states will also be saved.

Service data -> CF card

Special data are saved to the CF card. The function may only be carried out if the user has been asked to do so by a service engineer from the instrument manufacturer.

Software update

This function serves for reading in a new device software (firmware). To do this, a special CF card is required. Only a service engineer from the instrument manufacturer may perform the update.

CF card -> user list

The user list is read in from the data storage medium and activated in the paperless recorder.

7 Memory Manager

General information



The function *CF card update* reads out data that have not yet been read out. After read-out, data are not marked as read in the recorder but are not deleted.

Function *Backup → CF card* reads all data from internal memory, including what had already been read. After read-out, the data are marked as read in the recorder. The function *Backup → CF card* is therefore ideal for test and service work.



Only one data storage medium can ever be inserted at a time, either a CF memory card or a USB memory stick. Paperless recorders without option Stainless steel are equipped with two USB host interfaces (one on the front and one on the back). In this case also, only one can be used at a time, **never** both together.

8 Device Manager

The functions of the Device manager vary, depending on whether a user is logged in or not.

**No user
logged in**

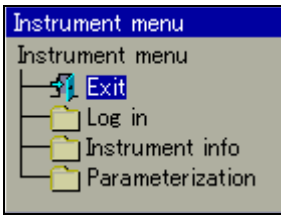
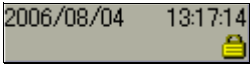

**“User”
logged in**

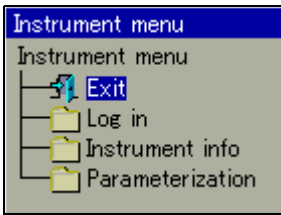
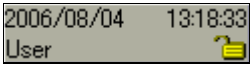

**User
“Master”
logged in**

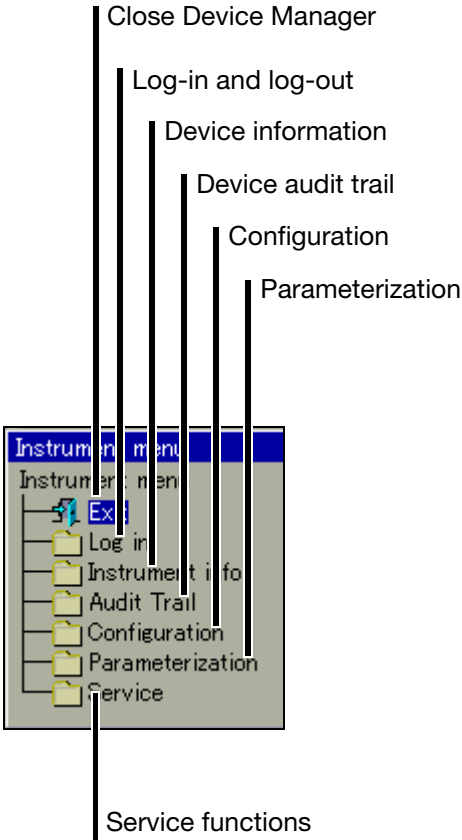
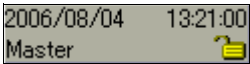

The differences between “No user logged in” and “User logged in” only become visible in the submenu “Parameterization”.

8 Device Manager

8.1 Close Device Manager

Close the device manager and reactivate the previous visualization.

8.2 Log-in and Log-out

- * Select the *Device manager* in the header, by rotating the control knob.
- * Activate the *Device manager* by pressing the control knob.
- * In the *Device manager* activate the function *Log in*.

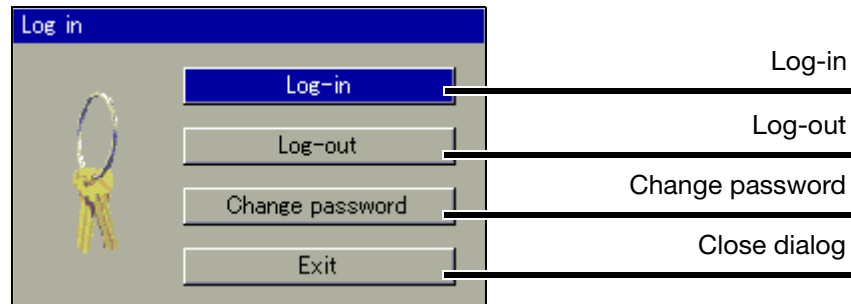

Default users



The paperless recorder is delivered ex-factory with an internal user list which contains two users.

1. User: Master password: 9200
2. User: User password: 0

The setup program can be used to alter the two user names and their passwords and access rights, and transfer this information to the device.

Log-in

- * In the menu *Device manager* → *Log-in*, activate the function *Log-in*.

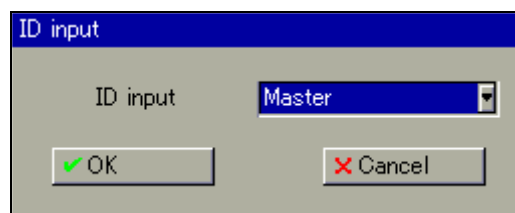

- * Select the user. The user name can be changed by rotating the control knob.

8 Device Manager

- * Select "OK" with the control knob, and press the control knob.



- * Enter the password by rotating and pressing the control knob, and finish the entry with "OK".

You are now logged in to the system.

2006/08/04 11:41:43
Master 

8 Device Manager

8.3 Device information

This function provides you with information on the hardware and software components of the instrument. The momentary values of all the internal and external inputs can also be checked.

The control knob can be rotated to display every single table. The function is terminated by pressing the control knob.

Version

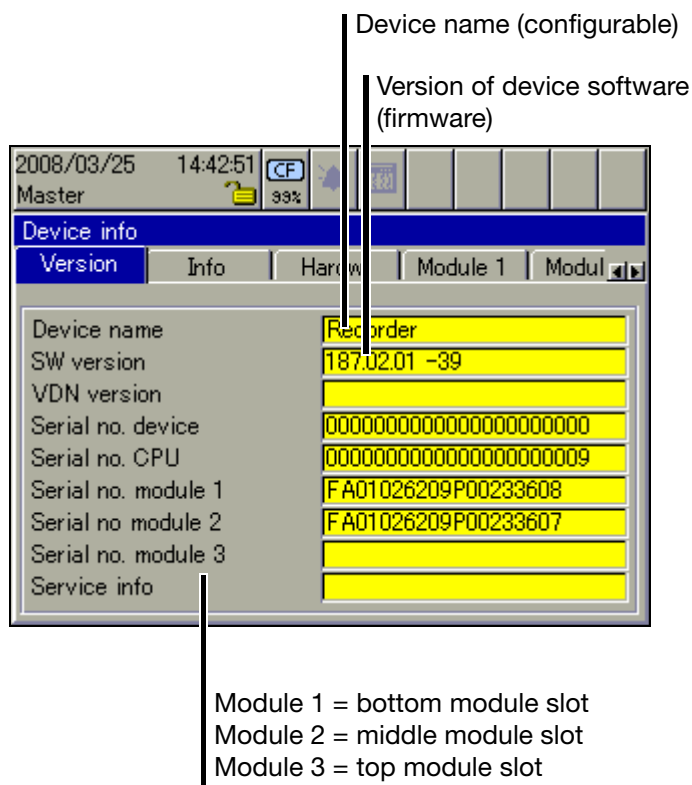

The screenshot shows the 'Device info' screen with the 'Version' tab selected. The screen displays the following information:

| | |
|---------------------|--------------------------|
| Device name | Recorder |
| SW version | 187.02.01 -39 |
| VDN version | |
| Serial no. device | 000000000000000000000000 |
| Serial no. CPU | 000000000000000000000009 |
| Serial no. module 1 | FA01026209P00233608 |
| Serial no. module 2 | FA01026209P00233607 |
| Serial no. module 3 | |
| Service info | |

Annotations:

- Device name (configurable)
- Version of device software (firmware)
- Module 1 = bottom module slot
- Module 2 = middle module slot
- Module 3 = top module slot

8 Device Manager

Info

Module 1 = bottom module slot
 Module 2 = middle module slot
 Module 3 = top module slot

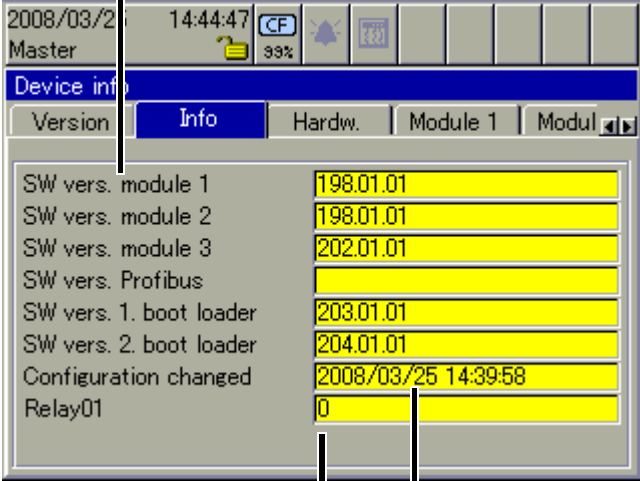

Date and time of last reconfiguration

Switching state of relay 1 (fitted as standard);
 0= not switched

Hardware

Bottom module slot
 Middle module slot
 Top module slot

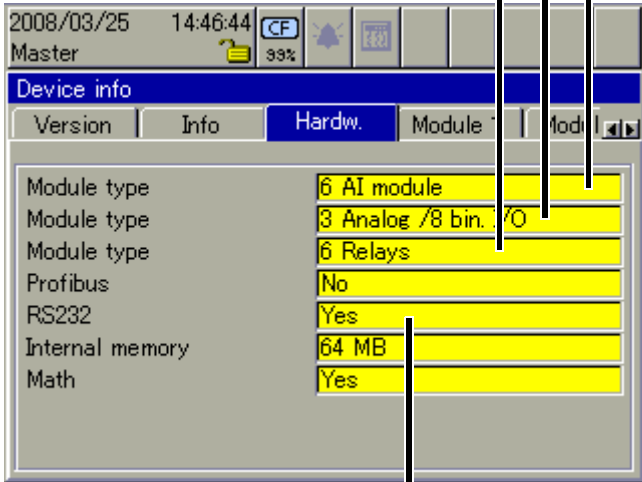

RS232 for barcode reader

8 Device Manager

Module 1

The picture below shows a module that has been fitted with 6 analog inputs. Depending on the hardware level, the picture may look different. Module 1 is in the bottom module slot.

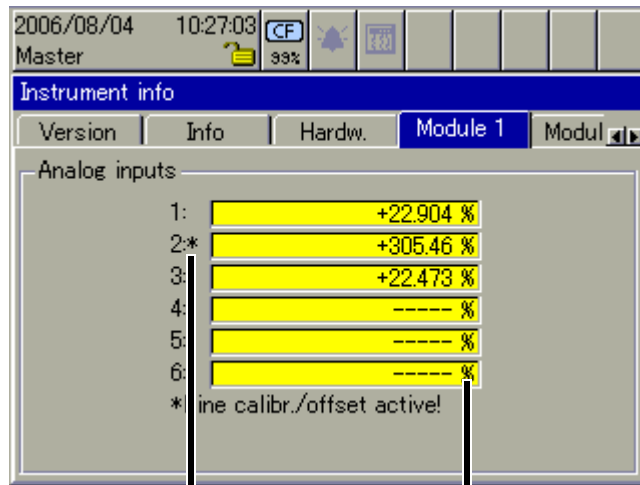

The * indicates that an offset or fine calibration is active on this channel.

Display of the current analog values from module

Module 2

The picture below shows a module that has been fitted with 3 analog inputs and 8 binary inputs/outputs. Depending on the hardware level, the picture may look different. Module 2 is in the middle slot.

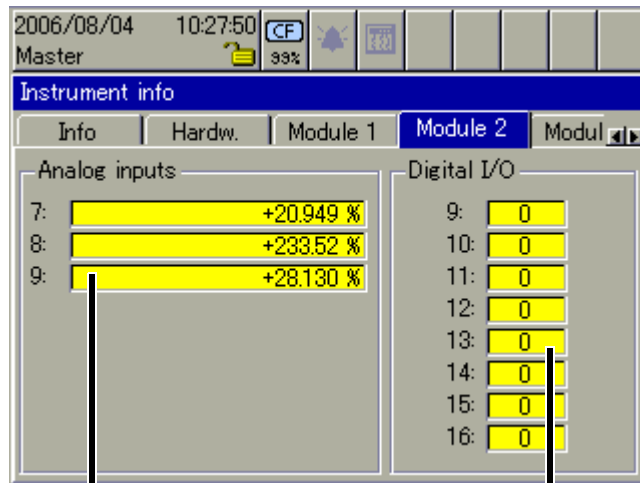

Display of the current analog values from module

States of the binary inputs/ outputs (0 = not active).

Module 3

The picture below shows a module that has been fitted with a relay card (6 relays). Depending on the hardware level, the picture may look different. Module 3 is in the top slot.

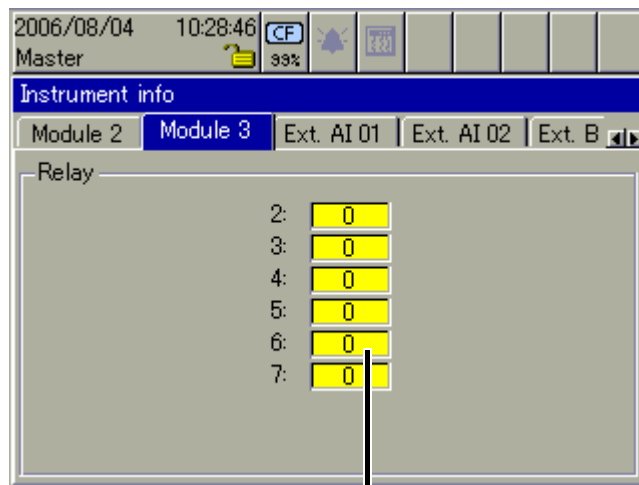

Switching state of relays
(0 = not switched).

Ext. analog input (AE) 1 – 2

The two windows show the current external analog inputs. External analog inputs are read into the recorder via one of the interfaces (e.g. through the Modbus Master function).

Ext. binary input (BE)

The window shows the current external binary inputs. External binary inputs are read into the recorder via one of the interfaces (e.g. through the Modbus Master function). Unlike the internal binary inputs/outputs, external binary outputs are not available.

Ext. texts

The window shows the current external texts, which can be integrated into the batch reports as label or information text. External texts are read into the recorder via one of the interfaces (e.g. through the Modbus Master function).

8 Device Manager

Eth. info 1

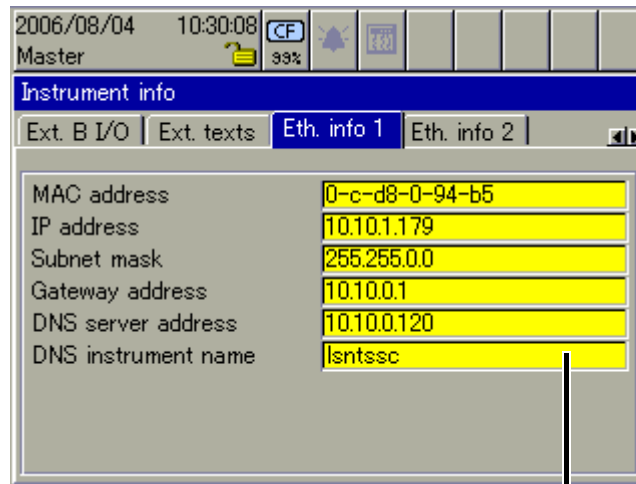

Information about the current Ethernet configuration

Eth. info 2

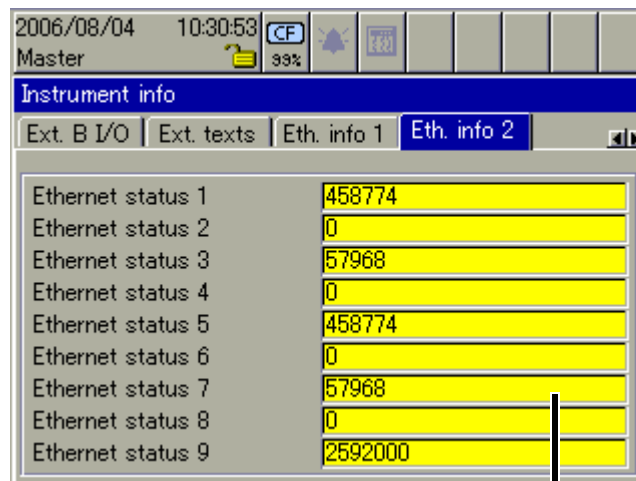

Information about the current Ethernet communication

| Parameter | Description |
|-------------------|--|
| Ethernet status 1 | Received Ethernet packets |
| Ethernet status 2 | Received Ethernet packets with errors |
| Ethernet status 3 | Transmitted Ethernet packets |
| Ethernet status 4 | Transmitted Ethernet packets with errors |

| Parameter | Description |
|-------------------|-------------------------------------|
| Ethernet status 5 | Received TCP packets |
| Ethernet status 6 | Received TCP packets with errors |
| Ethernet status 7 | Transmitted TCP packets |
| Ethernet status 8 | Transmitted TCP packets with errors |
| Ethernet status 9 | Received Lease time, in seconds |

USB info Information appears in the window via the USB interfaces. This information is only of interest for servicing.

Interface Information about the serial interfaces and PROFIBUS DP interface appears in the window. The user can see the set interface parameters without having to go to the configuration. Parameters are also visible if there are no users logged in on the instrument.

8.4 Device Audit Trail

The audit trail contains a log of all user actions on the recorder.

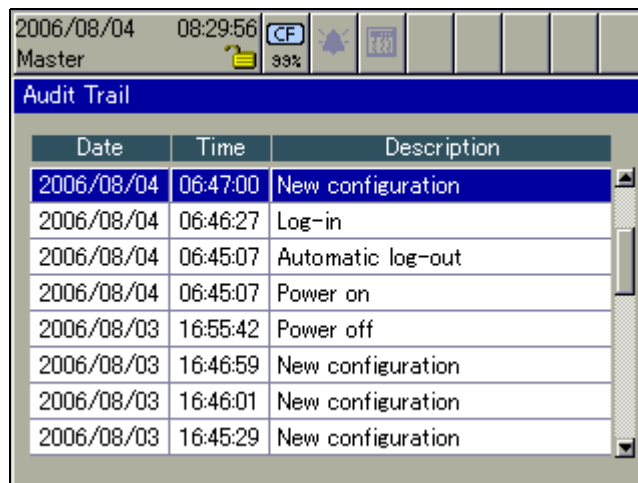

The screenshot shows a software window titled "Audit Trail". At the top, it displays the date "2006/08/04", time "08:29:56", and the user "Master". Below this is a table with three columns: "Date", "Time", and "Description". The table contains the following entries:

| Date | Time | Description |
|------------|----------|-------------------|
| 2006/08/04 | 06:47:00 | New configuration |
| 2006/08/04 | 06:46:27 | Log-in |
| 2006/08/04 | 06:45:07 | Automatic log-out |
| 2006/08/04 | 06:45:07 | Power on |
| 2006/08/03 | 16:55:42 | Power off |
| 2006/08/03 | 16:46:59 | New configuration |
| 2006/08/03 | 16:46:01 | New configuration |
| 2006/08/03 | 16:45:29 | New configuration |

The function is terminated by pressing the control knob.

8 Device Manager

8.5 Configuration

This function can be used to alter the configuration of the recorder.

⇒ Several chapters in this operating manual deal with the configuration, which starts in Chapter 10 "Configuration - General".



An alteration of the configuration results in the current recording being closed down and the new data being recorded in a separate time frame from the "old" data. It is not possible to present the data before reconfiguration and the data after reconfiguration as a single entity. The instrument works with a new configuration.

8.6 Parameterization

For parameterization, some functions will not be available if no user is logged in, or the user who is logged in does not have the access rights for these functions.

Only the setting of individual current batch numbers is enabled in the factory (default) setting.

⇒ Additional information can be found in Chapter 9 "Parameterization".

8.7 Service

The “Service” functions will also not be available if no user is logged in, or the user who is logged in does not possess access rights for these functions.

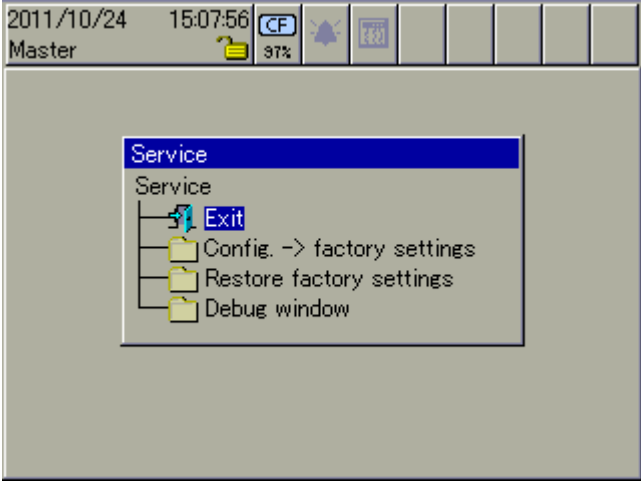

- Config. -> factory settings** The current configuration can be saved within the device as the new factory setting.

- Restore factory settings** The factory setting, e.g. created by “Set->curr. settings as default”, is called up and the instrument is reset.

- Debug window** Only a service engineer from the instrument manufacturer may use this function.

8 Device Manager

9 Parameterization

The functions in the Parameterization menu vary, depending on whether a user is logged in or not.

**No user
logged in**

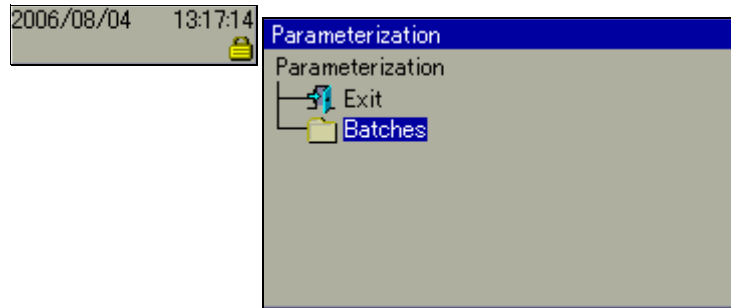

**“User”
logged in**

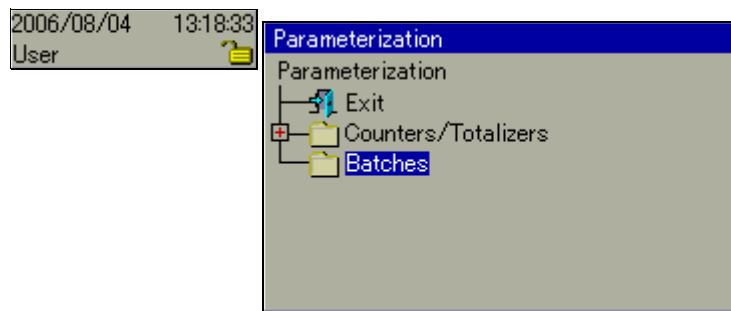

**User
“Master”
logged in**

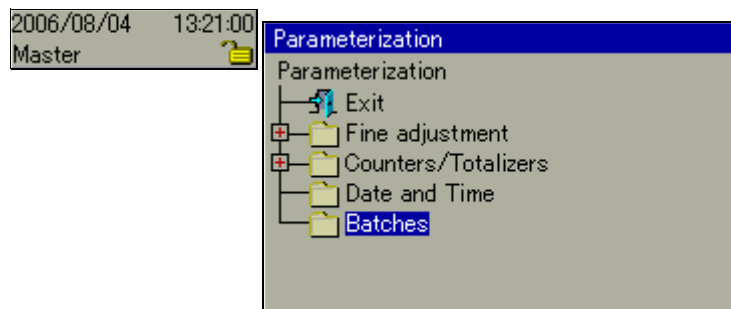

9 Parameterization

9.1 Fine calibration

Using "Fine calibration", an adjustment (correction) of the internal analog measurements can be activated. The adjustment is carried out using a linear equation.

Example

Systematic errors, such as those caused by an unsuitable probe mounting, have occurred in a plant. A probe provides measurements that cover a temperature range from 200 to 300 °C. It has been installed in a tunnel oven so unfavorably as to always indicate 10 °C less than the temperature of the charge. The incorrect measurement can be corrected through fine calibration.

Parameterization → Fine calibration → Analog input 1 → Actual start val. : 200 °C

Parameterization → Fine calibration → Analog input 1 → Target start val. : 210 °C

Parameterization → Fine calibration → Analog input 1 → Actual end val. : 300 °C

Parameterization → Fine calibration → Analog input 1 → Target end val. : 310 °C

9.2 Counters/integrators

With the aid of this function, the present counter and integrator states can be altered (for instance, to 0 or any start value). The alteration is documented in the event list whereby the old and the new values are specified. It is effective only once.

9.3 Date and time

Using this function, the current date and current time are set for the recorder. Additional functions for configuring date and time functions (e.g. daylight saving time) can be found in the menu *Configuration → Date and time*.

⇒ Chapter 24 "Configuration - Date and Time"

9.4 Batches/plants

Irrespective of the number of batches (plants) used, this function is available for configuring the start numbers of up to three batch numbers. The batch numbers can be switched into display when recording batches in the batch report. At the end of a batch, the value is incremented by one.

Example:

Batch numbers

| Batch no. | Value |
|-------------|-------|
| Batch no. 1 | 7 |
| Batch no. 2 | 17 |
| Batch no. 3 | 10 |

Current batch for Plant 1

| | |
|----------------|-----------------|
| Program name | Default Text 01 |
| Customer info | Default Text 03 |
| Batch name | Default Text 05 |
| Batch number | 000000007 |
| Batch start | |
| Batch end | |
| Batch duration | 00:00 |

Batch number 1

Batch numbers are assigned to a currently present batch in the menu *Configuration* → *Batches/plants*.

⇒ Chapter 23 "Configuration – Batches/Plants"

9 Parameterization

10 Configuration - General

The menu *Device manager* → *Configuration* can only be called up if a user is logged in who is authorized to perform the configuration.



With the aid of the setup program, the user rights can be altered and transferred to the paperless recorder via the interface or CF card.

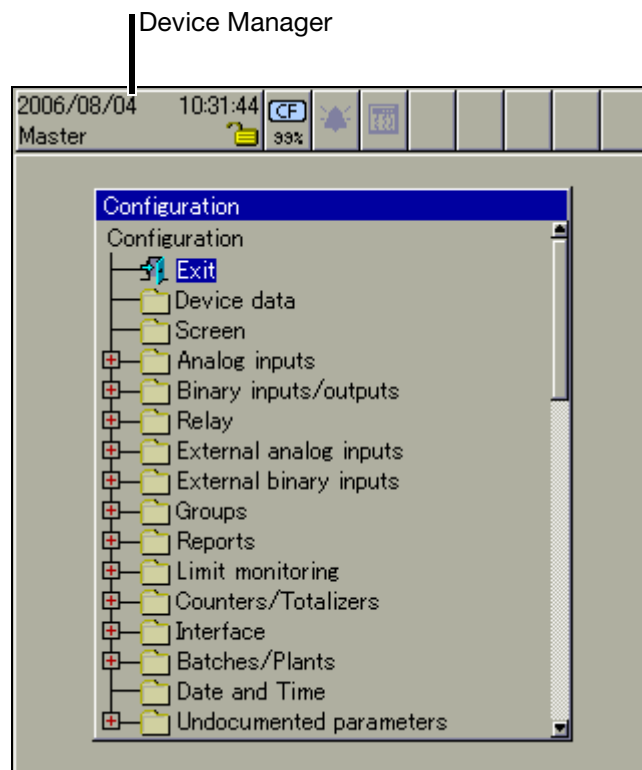

- * Select the submenu by rotating the control knob.
- * Activate the submenu by pressing the control knob.

For clarity, the description of the individual submenus has been divided among the following chapters.

10 Configuration - General

11 Configuration - Device Data

Overview

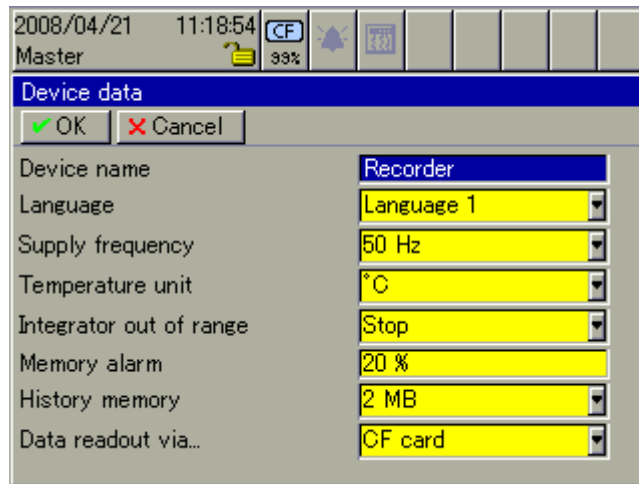

Device (instrument) name

The device name (up to 15 characters) is used for the identification of the paperless recorder in the instrument (Device info menu), in the setup program or in the PCA Communications software PCC.

Language

First choose between the two instrument languages. All texts (fixed and variable ones) can be altered through the setup program. Individual texts in any language can be implemented in this way.

Supply frequency

Set the frequency of the supply voltage used.

Temperature unit

Set the temperature unit of your choice. When configuring the analog channels, the measurement range limits are shown in the chosen unit.

Integrator with Out of Range

The response of the integrator (totalizer) channels is set here if the value of the input signal for an integrator is invalid.

| | |
|---------|--|
| Stop | Integration is stopped. |
| Invalid | Integration is set to invalid ("-----"). |

Memory alarm (warning)

The memory alarm (warning) is triggered when the available measurement data memory has fallen below the configured value. With regard to the memory alarms, a distinction is made between

- "readout via CF card",
- "readout via interface" and
- "internal memory".



If the memory alarms are set, there is a danger of a data loss. The data must be read out of the recorder without delay.

11 Configuration - Device Data

History (data) memory

Here you can determine the size of the History memory. The memory is used to show stored measurement data that are outside the present curve view.



The History presentation is started through the History function in the header.



⇒ Chapter 5 "Memory Presentation (History)"

Data readout via ...

The memory readout type of your choice is selected here. The parameter only affects the header, and when there is no CF card in the slot.

| | |
|-----------|--|
| Interface |  <p>This shows the available memory for reading out data via one of the interfaces (RS232/RS485, setup interface or Ethernet). The data readout can, for instance, be implemented via the PCA Communications software PCC.</p> |
| CF card |  <p>This shows the available memory for reading out data via the CF memory card.</p> |

If the symbol is shown in red, a memory alarm for the corresponding type of readout is present.

If the CF card is inserted, the available memory of the CF card is displayed. The parameter "Read data via ... (Display CF capacity)" is irrelevant at this point.



The minimum size of available storage space (in %) is determined through the parameter *Configuration* → *Device data* → *Memory alarm*. If less memory space is available than has been set, there will be an entry in the event list.

12.1 Brightness ... Show text image

Overview

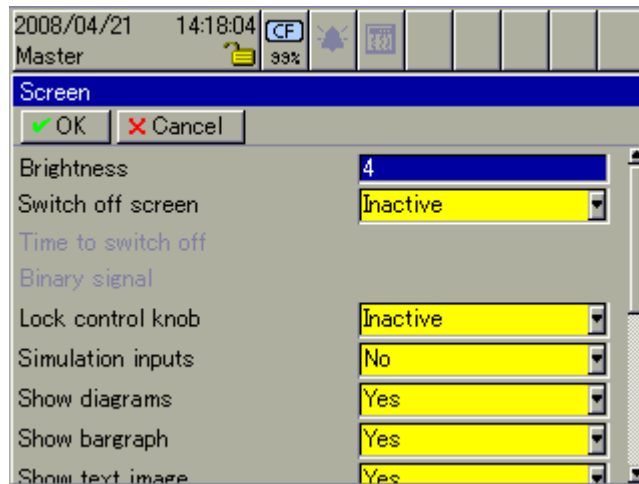

Brightness

With the aid of this function, the brightness of the screen can be altered in four stages (1 = darker; 4 = brighter). Any alteration to this parameter will become effective when the *Instrument (device) data* menu is closed.

Switch off screen

For screen saving, a screen switch-off (screen saver) can be activated here.

The switch-off can be activated by means of a waiting time or a control signal.

Time to switch off (waiting time)

If the control knob is not operated within a period from 10 to 32767 seconds, screen saving will become active and the screen goes dark.

Binary signal (control signal)

The switch-off is initiated by one of the binary signals. A binary signal may, for instance, be a binary input, a relay state, or a batch activation.

Lock control knob

A binary signal can be selected with the function. It can be used to lock the control knob as long as the signal is active.

Simulate inputs

If the parameter is activated ("Yes"), all recorder inputs and outputs will be ignored and pseudo data will be displayed on the screen.



The inputs and outputs move to a non-defined state. This parameter should only be activated for test purposes, and only if the relays and binary outputs are not wired up.

12 Configuration - Screen

Show curves (diagrams) This parameter determines whether curve presentation may be called up in the Visualization menu.

| | |
|-----|--------------------------------------|
| Yes | Curve presentation can be called up. |
|-----|--------------------------------------|

Show bar graph This parameter determines whether bar graph presentation may be called up in the Visualization menu.

| | |
|-----|--|
| Yes | Bar graph presentation can be called up. |
|-----|--|

Show text image This parameter determines whether textual presentation may be called up in the Visualization menu.

| | |
|-----|--|
| Yes | Textual presentation can be called up. |
|-----|--|

12.2 Show process image ... Bar code -> current batch

Overview

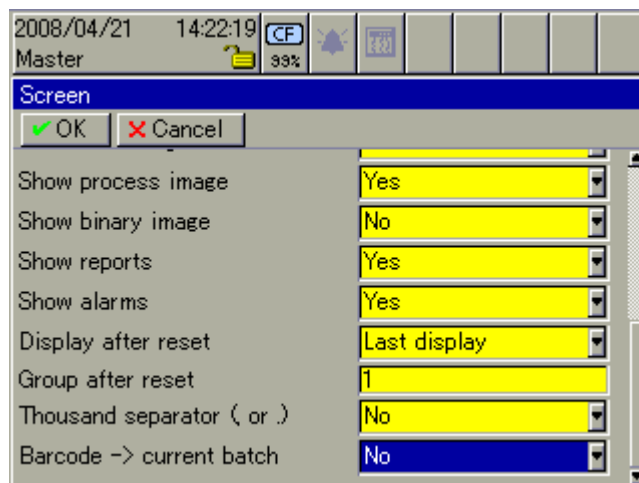

Show process image This parameter determines whether process image presentation may be called up in the Visualization menu.

| | |
|-----|--|
| Yes | Process image presentation can be called up. |
|-----|--|

The display shows selected measurement signals and background pictures in one process screen (one process screen for each group). The setup program is used to prepare and configure images.

12 Configuration - Screen

Show binary image

This parameter determines whether binary screen presentation may be called up in the Visualization menu.

| | |
|-----|--|
| Yes | Binary screen presentation can be called up. |
|-----|--|

In the presentation, the analog channels are dispensed with, only the binary channels are made visible.

Show reports

This parameter determines whether report presentation may be called up in the Visualization menu.

| | |
|-----|---------------------------------------|
| Yes | Report presentation can be called up. |
|-----|---------------------------------------|

Each report is run on all analog channels of a group. Each group has its own configurable report.

Show alarms

This parameter determines whether alarm messages are displayed in the "status & title bar".

| | |
|-----|---|
| Yes | Alarms are displayed.  |
|-----|---|

Display after reset

This parameter determines which visualization or representation is shown on the screen after switch-on (connecting the supply voltage).

| | |
|------------------------------------|---|
| Last display | The display that was active before switch-off is restarted. |
| Curve diagram ... Batch diagram | A specific visualization is to be displayed. |

Group after reset

This parameter determines which group is displayed on the screen in "Display after a reset" (visualization after switch-on).

Thousands separator

This parameter determines whether a thousands separator is inserted for the visualization of the counter and integrator counts.

| | |
|-----|--|
| Yes | Thousands separator is inserted.  |
|-----|--|

Bar code -> current batch

This parameter determines whether the visualization of the current batch data will be started automatically when acquiring a bar code with a connected barcode reader.

| | |
|-----|--|
| Yes | The data for the current batch will appear in the display automatically. |
|-----|--|

12 Configuration - Screen

13 Configuration - Analog Inputs

The analog inputs of the recorder are configured in this menu. How to connect the inputs to the recorder is described in the Installation Instructions 59488 (connectors 8 to 13, depending on the equipment level of the individual module slots).

13.1 Sensor ... Offset

Overview

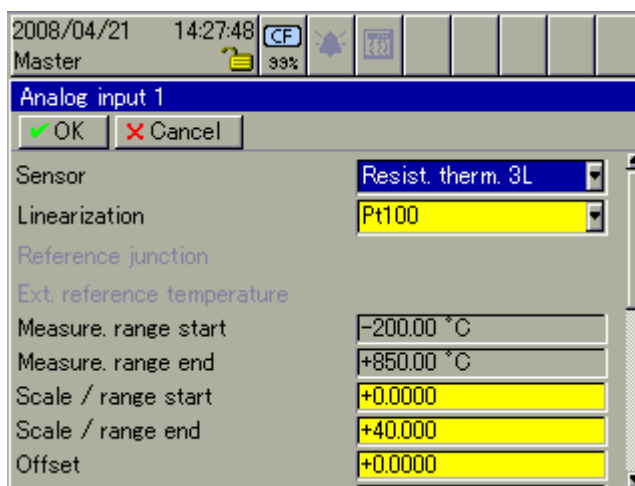

Sensor

Type of the connected sensor (e.g. RTD in 3-wire circuit). The setting “Inactive” means that the channel is not connected.



An analog channel can be used in a group, even though its sensor is set to “Inactive”. The channel is marked as invalid “-----” in the curve presentation.

Linearization

In addition to the usual linearizations (e.g. Pt100), four customer-specific linearizations are available. The associated linearization tables have to be created using the setup program.

Reference junction (cold junction)

The settings for the cold junction are only available if “thermocouple” has been selected as the sensor.

| | |
|----------------|--|
| Internal Pt100 | The Pt100 resistance thermometers within the instrument are used for the comparison measurement. |
| Ext. const. | A constant temperature is selected for comparison. |

Ext. reference temperature

The cold-junction temperature is entered here if “thermocouple” has been configured as the sensor and “Ext. const.” as the cold junction.

Measure. range start/ range end

The limits for the range are determined by the sensor type that has been connected and automatically entered. The start and end can be altered for these sensor types: current, voltage, potentiometer and resistance transmitter.

13 Configuration - Analog Inputs

If the limits can be altered, a free scaling function is activated within the instrument, i.e. the value “range start” is transformed to the value “scaling start” and the value “range end” to the value “scaling end”.

If the limits are not alterable, the predefined range can only be restricted via “scaling start” and “scaling end”.

Scale / range start / range end

Visualization on the recorder screen takes place within the limits configured here.

If the measurement goes outside the limits configured here, the error constant for overrange or underrange is written to the measurement variable. When the data are visualized, “>>>>” appears for overrange and “<<<<<” for underrange.

Offset

This function serves for the parallel shifting of the measurement curve in the range of ± 100 referred to the scaling limits.

13.2 Filter Constant ... Unit

Overview

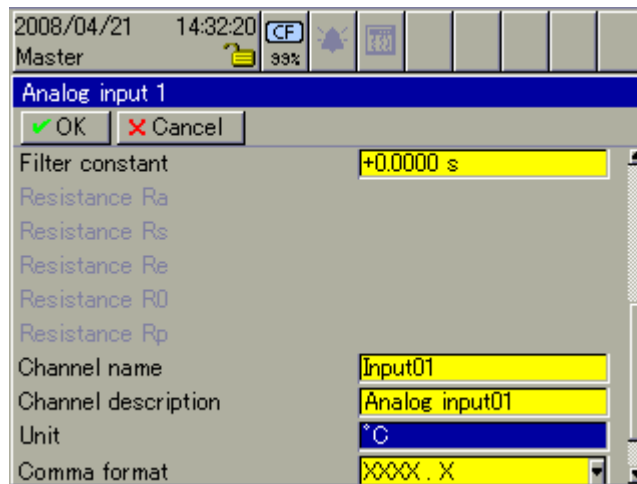

Filter constant

All analog inputs are equipped with a 2nd order digital filter. The filter ensures that the noise of the input signal is reduced, it is “smoothed”. The larger the filter constant, the larger the smoothing will be.

Resistance Ra – Re

The resistance values can only be entered with the sensor type “resistance transmitter”.

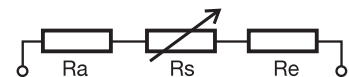
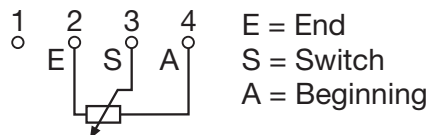

| | |
|----|---|
| Ra | Resistance between slider and start, if the slider is at the start. |
|----|---|

13 Configuration - Analog Inputs

| | |
|----|---|
| Re | Resistance between slider and start, if the slider is at the start. |
| Rs | Total resistance minus Ra and Re. |

The sum of the resistances ($R_a+R_e+R_s$) must not exceed 4000 Ohm.

Resistance R0 – Rp

The resistance values can only be entered with the sensor type “potentiometer”.

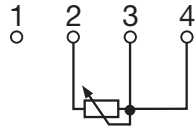

| | |
|----|---|
| R0 | Resistance between slider and start, if the slider is at the start. |
| Rp | Total resistance minus R0. |

The sum of the resistances (R_0+R_p) must not exceed 4000 Ohm.

Channel name (designation)

Short designation for the analog input, up to 7 characters. The channel name is displayed in the individual visualization modes, together with the channel designation.

Channel description

Description of the analog input, up to 21 characters. The channel description is displayed in the individual visualization modes, together with the channel name.

Unit

Unit in which the acquired measurement signal is to be displayed, up to 5 characters. The unit is displayed wherever the measurement is presented numerically.

13 Configuration - Analog Inputs

13.3 Comma format ... Alarm Configuration

Overview

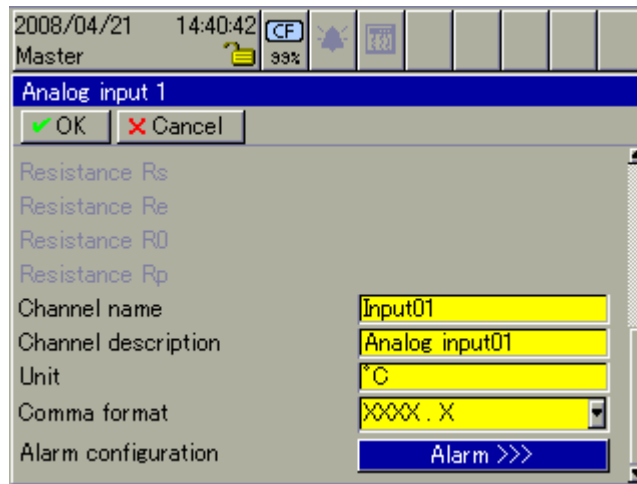

Comma format (decimal place)

The decimal place serves to determine the number of integer and decimal places for the numerical presentation of the measurements. If required, the instrument will automatically switch to a different format, in order to be able to show all the integer places. As a rule: configuration all integer places must be displayed.

Alarm configuration

Opens the submenu for the configuration of both alarms.

13 Configuration - Analog Inputs

13.4 Alarm configuration

13.4.1 Status ... Alarm text 2

Overview

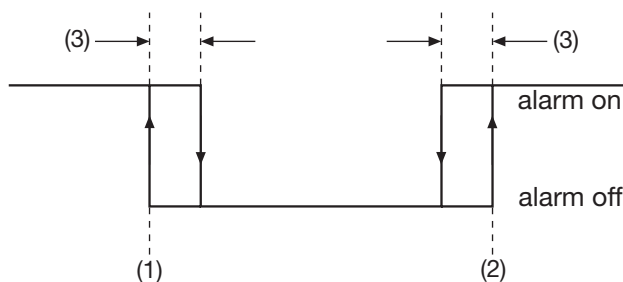
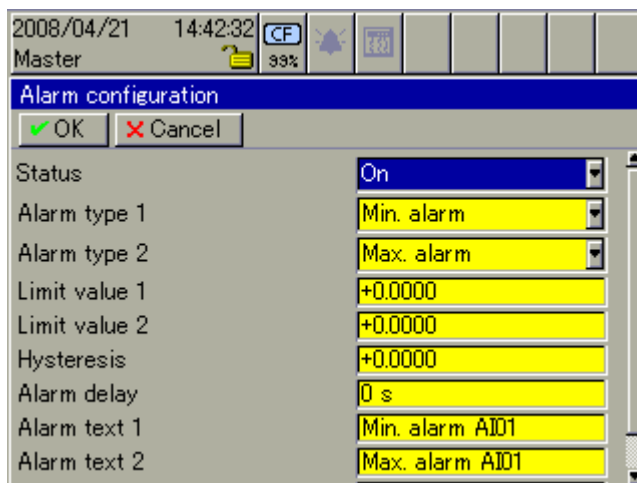

- (1) = Low alarm
- (2) = High alarm
- (3) = Hysteresis

Status

Status activates alarm monitoring.

| | |
|----|-----------------------------|
| On | Alarm monitoring is active. |
|----|-----------------------------|

Alarm type 1/ alarm type 2

“Min alarm” and “Max alarm” are available for each alarm type.

| | |
|-----------|---|
| Min alarm | Alarm is initiated if the value has fallen below the limit. |
| Max alarm | Alarm is initiated if the value has gone above the limit. |

Limit value 1/ limit value 2

Limit at which the alarm is initiated.

13 Configuration - Analog Inputs

Hysteresis (differential) The hysteresis serves to prevent an unsteady (flickering) alarm state (repeated, brief switching on and off due to the noise of the input signal). The higher the value, the larger the amount by which the present measurement must go above or below the limit in order to cancel the alarm.

Alarm delay This parameter delays the reporting of an alarm. If the alarm is no longer present after the alarm delay time has elapsed, it will not be triggered.

Alarm text 1/ alarm text 2 There is an alarm text for each type of alarm, which, in the event of an alarm, is displayed in the “status & title bar” and entered in the event list.

13.4.2 Alarm rejection

Overview

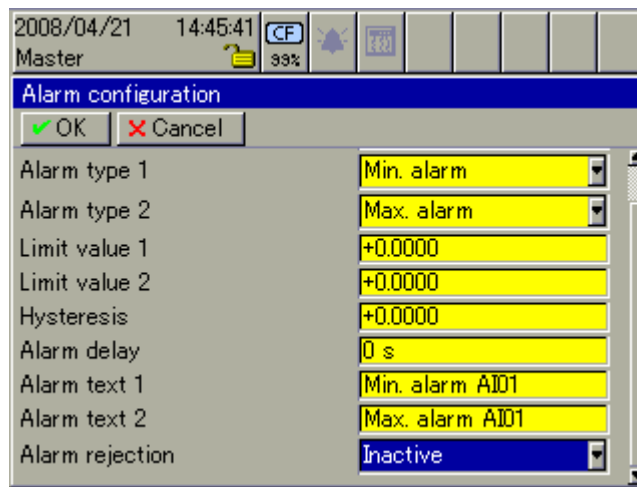

Alarm rejection This function makes it possible to suppress the alarms of a channel when a binary signal is active (HIGH state).

- Both alarms are suppressed.
- There is no indication of overrange, underrange, or probe break.
- Alarms that are present become inactive.
- Overrange und underrange alarms become inactive.
- There is no alarm or event entry when alarm rejection is active.

14 Configuration - Binary Inputs/Outputs

The binary inputs and outputs of the recorder are configured in this menu. How to connect the inputs and outputs to the recorder is described in the Installation Instructions 59488 (connectors 9, 11 or 13, depending on the equipment level of the individual module slots).

14.1 Function ... Alarm Configuration

Overview

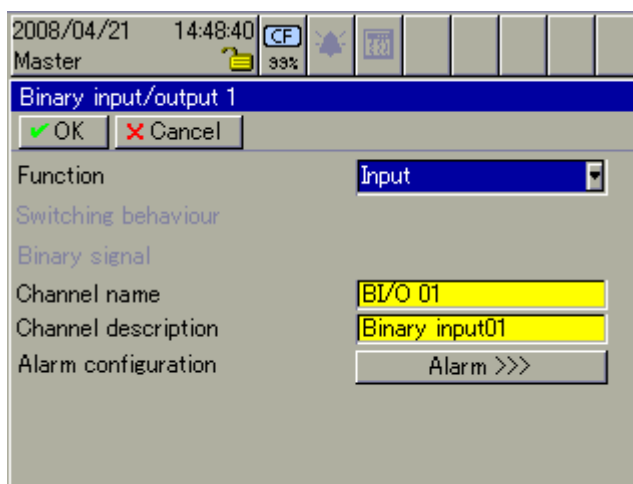

Function

This parameter determines whether a binary input or a binary output is to be used.

Switching action

Switching action is only available if a binary output is used and determines whether the output should operate as a make (SPST-NO) or break (SPST-NC) contact.

| | |
|-----------------|---|
| Make (SPST-NO) | The binary output is not switched (open) when the operating signal is inactive, and closed when the operating signal is active. |
| Break (SPST-NC) | The binary output is closed when the operating signal is inactive, and not switched (open) when the operating signal is active. |

Binary signal

This parameter determines which binary signal is to be used as an operating signal for the binary output.



If a binary input/output has been configured for the output, the same signal may not be used as the operating signal.

Channel name (designation)

Short designation for the input or output, up to 7 characters. The channel name is displayed in the individual visualization modes, together with the channel designation.

14 Configuration - Binary Inputs/Outputs

Channel description Description of the input or output, up to 21 characters. The channel description is displayed in the individual visualization modes, together with the channel name.

Alarm configuration Opens the submenu for the configuration of the alarm monitoring.

14.2 Alarm Configuration

Overview

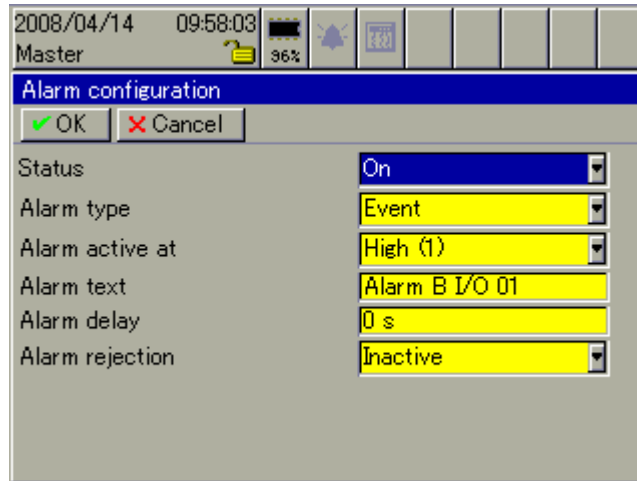

Status Status activates alarm monitoring.

| | |
|----|-----------------------------|
| On | Alarm monitoring is active. |
|----|-----------------------------|

Alarm type The alarm type determines whether the activating/inactivating of an input or output is to be evaluated as a genuine alarm or only as an event.

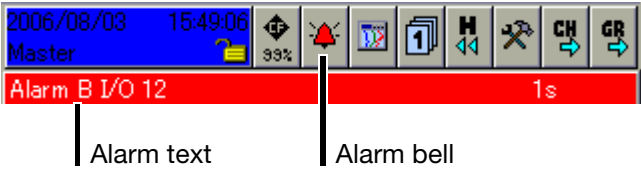
| | |
|-------|--|
| Event | The alarm text is entered in the event list only. |
| Alarm | The alarm text is entered in the alarm list and the event list. In addition, the alarm text appears in the “status & title bar”, and the alarm bell is shown in red.  |

Alarm active on Determines whether the alarm is present with active or inactive input/output.

| | |
|----------|----------------------------------|
| High (1) | Alarm with active input/output |
| Low (0) | Alarm with inactive input/output |

14 Configuration - Binary Inputs/Outputs

| | |
|------------------------|---|
| Alarm text | Text that is entered in the event or alarm list and displayed in the “status & title bar”, with the alarm type “Alarm”. |
| Alarm delay | This parameter delays the reporting of an alarm. If the alarm is no longer present after the alarm delay time has elapsed, it will not be triggered. |
| Alarm rejection | <p>This function makes it possible to suppress alarms when a binary signal is active (HIGH state).</p> <ul style="list-style-type: none">- Both alarm types (alarm and event) are suppressed.- Alarms that are present become inactive.- There is no alarm or event entry when alarm rejection is active. |

14 Configuration - Binary Inputs/Outputs

15 Configuration - Relay

The response of the relay(s) of the recorder are configured in this menu. How to connect the relay(s) is described in the Installation Instructions 59488 (connectors 1 and 14, depending on the equipment level of the individual module slots).

Overview

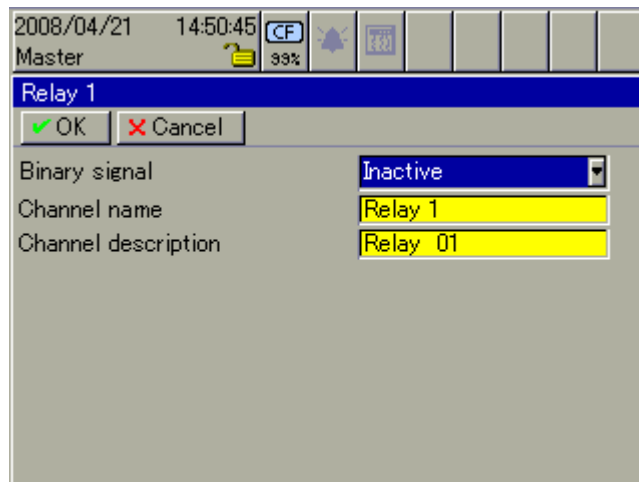

Binary signal Selection of the signal the chosen relay is to switch.

Channel name (designation) Short designation for the relay, up to 7 characters. The channel name is displayed in the individual visualization modes, together with the channel designation.

Channel description Description of the relay, up to 21 characters. The channel description is displayed in the individual visualization modes, together with the channel name.

15 Configuration - Relay

16 Configuration - External Analog Inputs

The external analog inputs that are connected to the recorder are configured in this menu. The external inputs are connected via

- one of the two serial interfaces (connector 2 or 7),
- the PROFIBUS-DP interface (connector 3 - option),
- the setup interface (connector 5) or
- the Ethernet interface (connector 6).

In the case of the two serial interfaces (connector 2 or 7), external inputs can be connected as a Modbus slave and as a Modbus master. Please take note of the parameters when configuring the serial interface.



Please avoid connecting the external inputs to the recorder via two interfaces. The interfaces will overwrite each other.

16.1 Range Start ... Alarm Configuration

Overview

Range start/ range end

Start and end of scaling in the recorder.

If the measurement goes outside the limits configured here, the error constant for overrange or underrange is written to the measurement variable. When the data are visualized, ">>>>" appears for overrange and "<<<<" for underrange.

Channel name (designation)

Short designation for the external analog input, up to 7 characters. The channel name is displayed in the individual visualization modes, together with the channel designation.

Channel description

Description of the external analog input, up to 21 characters. The channel description is displayed in the individual visualization modes, together with the channel name.

16 Configuration - External Analog Inputs

- Unit** Unit in which the acquired measurement signal is to be displayed, up to 5 characters. The unit is displayed wherever the measurement is presented numerically.
- Comma format** The decimal place serves to determine the number of integer and decimal places for the numerical presentation of the measurements. If required, the instrument will automatically switch to a different format, in order to be able to show all the integer places. As a rule: all integer places must be displayed.
- Alarm sconfiguration** Opens the submenu for the configuration of both alarms.

16.2 Alarm configuration

16.2.1 Status ... Alarm text 2

Overview

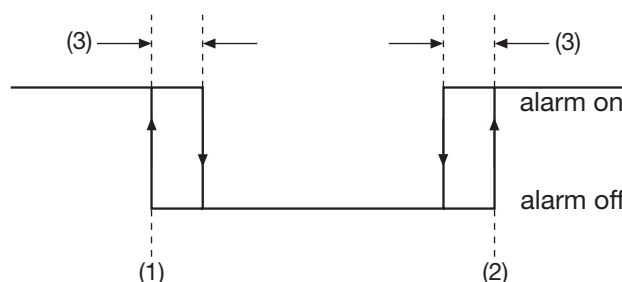
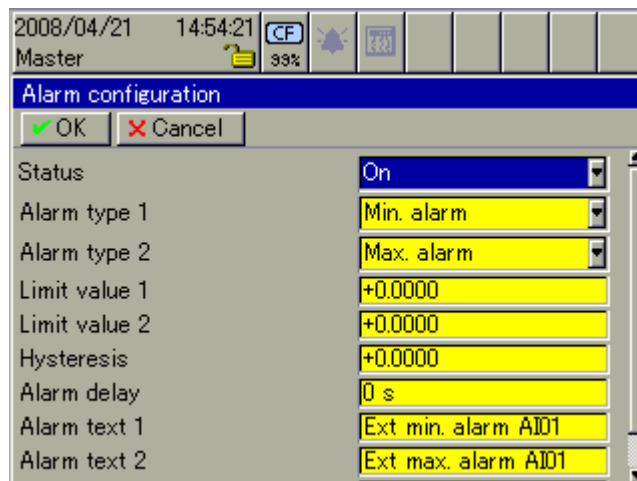

- (1) = Low alarm
- (2) = High alarm
- (3) = Hysteresis

16 Configuration - External Analog Inputs

Status

Status activates alarm monitoring.

| | |
|----|-----------------------------|
| On | Alarm monitoring is active. |
|----|-----------------------------|

Alarm type 1/ alarm type 2

“Min alarm” and “Max alarm” are available for each alarm type.

| | |
|-----------|---|
| Min alarm | Alarm is initiated if the value has fallen below the limit. |
| Max alarm | Alarm is initiated if the value has gone above the limit. |

Limit value 1/ limit value 2

Limit at which the alarm is initiated.

Hysteresis (differential)

The hysteresis serves to prevent an unsteady alarm state (repeated, brief switching on and off due to the noise of the input signal). The higher the value, the larger the amount by which the present measurement must go above or below the limit in order to cancel the alarm.

Alarm delay

This parameter delays the reporting of an alarm. If the alarm is no longer present after the alarm delay time has elapsed, it will not be triggered.

Alarm text 1/ alarm text 2

There is an alarm text for each type of alarm, which, in the event of an alarm, is displayed in the “status & title bar” and entered in the event list.

16 Configuration - External Analog Inputs

16.2.2 Alarm rejection

Overview

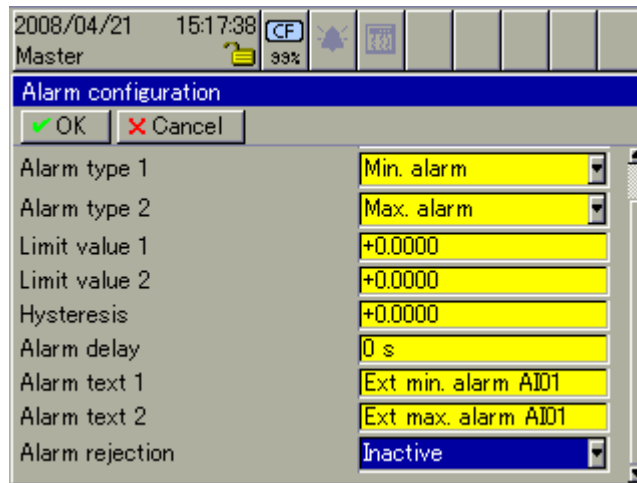

Alarm rejection This function makes it possible to suppress alarms when a binary signal is active (HIGH state).

- Both alarms are suppressed.
- There is no indication of overrange, underrange or probe break.
- Alarms that are present become inactive.
- Overrange und underrange alarms become inactive.
- There is no alarm or event entry when alarm rejection is active.

17 Configuration - External Binary Inputs

The external binary inputs that are connected to the recorder are configured in this menu. The external inputs are connected via

- one of the two serial interfaces (connector 2 or 7),
- the PROFIBUS-DP interface (connector 3 - option),
- the setup interface (connector 5) or
- the Ethernet interface (connector 6).

In the case of the two serial interfaces (connector 2 or 7), external inputs can be connected as a Modbus slave and as a Modbus master. Please take note of the parameters when configuring the serial interface.



Please avoid connecting the external inputs to the recorder via two interfaces. The interfaces will overwrite each other.

17.1 Channel Name ... Alarm Configuration

Overview

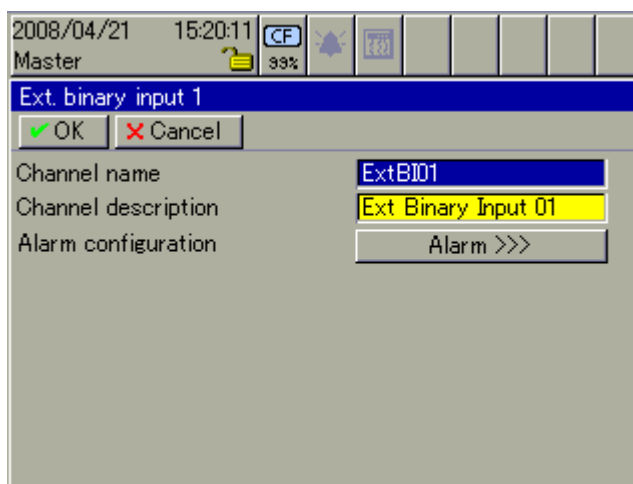

Channel name (designation) Short designation for the external binary input, up to 7 characters. The channel name is displayed in the individual visualization modes, together with the channel designation.

Channel description Description of the external binary input, up to 21 characters. The channel description is displayed in the individual visualization modes, together with the channel name.

Alarm configuration Opens the submenu for the configuration of both alarms.

17 Configuration - External Binary Inputs

17.2 Alarm Configuration

Overview

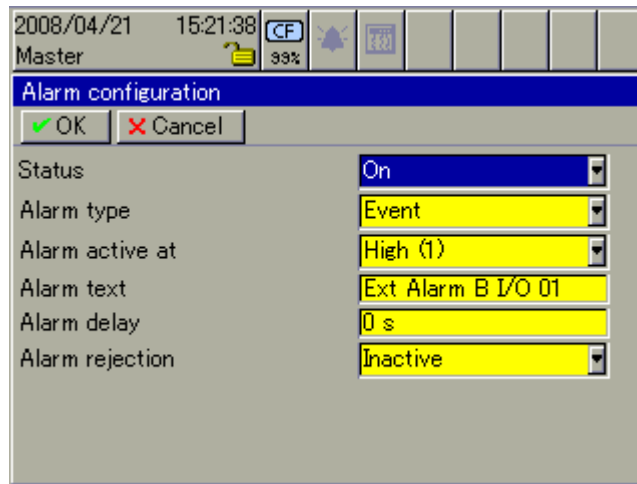

Status Status activates alarm monitoring.

| | |
|----|-----------------------------|
| On | Alarm monitoring is active. |
|----|-----------------------------|

Alarm type The alarm type determines whether the activating/inactivating of an input is to be evaluated as a genuine alarm or only as an event.

| | |
|-------|---|
| Event | The alarm text is entered in the event list only. |
| Alarm | The alarm text is entered in the alarm list and the event list. In addition, the alarm text appears in the “status & title bar”, and the alarm bell is shown in red.  <div style="display: flex; justify-content: space-around; margin-top: 5px;"> Alarm text Alarm bell </div> |

Alarm active on Determines whether the alarm is present with an active or inactive input.

| | |
|----------|----------------------------|
| High (1) | Alarm with active input. |
| Low (0) | Alarm with inactive input. |

Alarm text Text that is entered in the event or alarm list and displayed in the “status & title bar”, with the alarm type “Alarm”.

Alarm delay This parameter delays the reporting of an alarm. If the alarm is no longer present after the alarm delay time has elapsed, it will not be triggered.

17 Configuration - External Binary Inputs

- Alarm rejection** This function makes it possible to suppress alarms when a binary signal is active (HIGH state).
- Both alarm types (alarm and event) are suppressed.
 - Alarms that are present become inactive.
 - There is no alarm or event entry when alarm rejection is active.

17 Configuration - External Binary Inputs

18 Configuration - Groups

In the Groups menu you can determine which channels (analog or binary, math, internal or external, counters and integrators) are to be displayed and/or recorded. Furthermore, you can decide here how data are to be recorded (storage cycle, storage procedure, economy operation).

If batches are used, then these have a fixed assignments to the groups.

| Plant number | Group | Plant (batch) |
|--------------|-------------------------------|------------------------|
| 0 | 1 ... 9 | None |
| 1 | 1 ... 9 | 1 |
| 2 | 1 ... 3 4 ... 6 7 ... 9 | 1 2 Not assigned |
| 3 | 1 ... 3 4 ... 6 7 ... 9 | 1 2 3 |



In order for a batch to be usable, its main group must be active (status = "Display" or "Display, save") and at least one analog channel in the group must be assigned.

| Batch for plant | Main group |
|-----------------|------------|
| 1 | 1 |
| 2 | 4 |
| 3 | 7 |

Overview

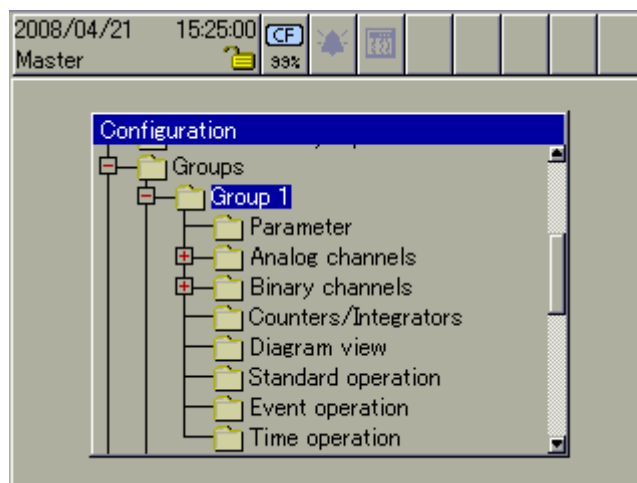

18 Configuration - Groups

18.1 Parameter

Overview

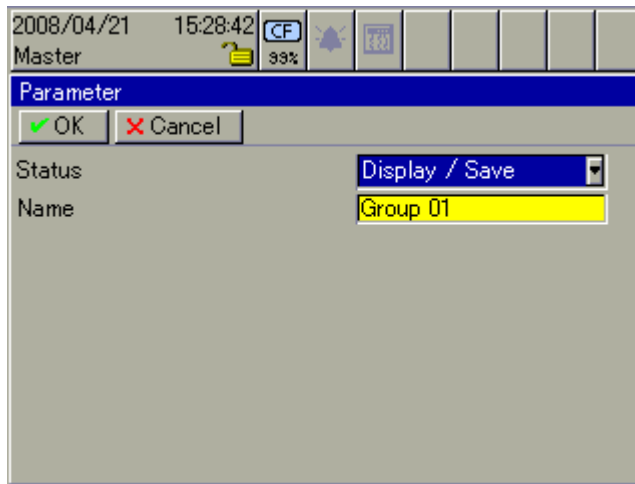

Status

This parameter determines what happens to the group.

| | |
|------------------|---|
| Inactive | The data for the group will neither be displayed nor stored. This setting is only available from Group 2 on. If Group 4 or 7 is inactive, then the batch cannot be recorded for Plant 2 or 3. |
| Display only | The data for the group are displayed on the screen. |
| Display and save | The data for the group are displayed on the screen and stored. The group data can only be evaluated from a PC if they are stored. |

Name

Description of the group, up to 21 characters. The description is displayed in the individual visualization modes.

18.2 Analog Channels

Overview Channel 1

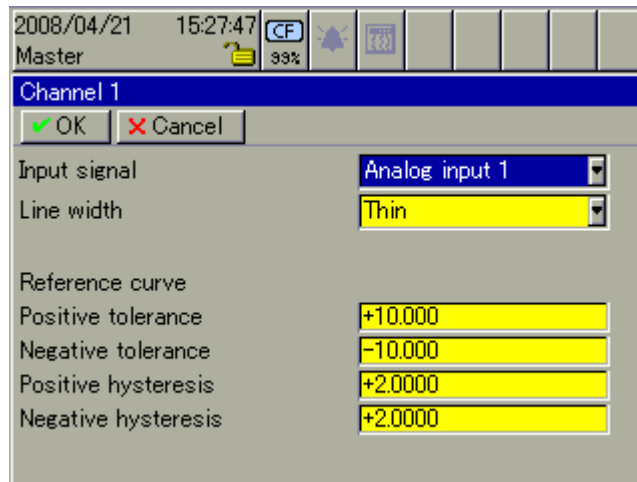

Input signal

The input (or input signal) selected here will be used as channel no. 1 for the group. All internal or external analog channels, as well as math channels (available as an extra), can be chosen.

Channel 1 has been assigned a special task: it is used as a reference curve for the other channels of the group. All the other channels of the group can be compared with Channel 1, independently of each other. On leaving the configured tolerance band, an alarm will be initiated, an alarm text will appear in the “status & title bar” and will be entered in the alarm or event list.



A comparison of the tolerance band is only possible within the scaling limits. In the event of overrange/underrange on a channel, there will be LOW as well as HIGH alarm for all the other functions (in this particular case: positive and negative tolerance).

Line width

Determines the width of the graphical measurement display.

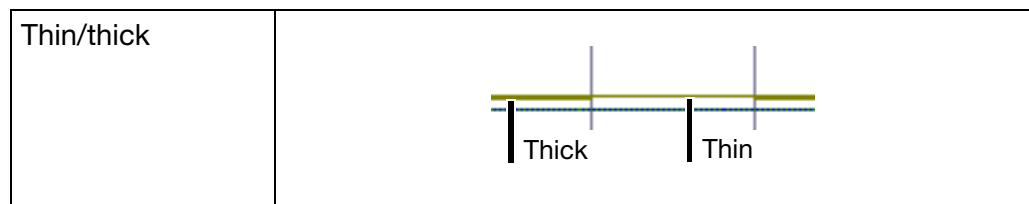

Positive tolerance

“Positive tolerance” and the present measurement from Channel 1 form the upper limit for the tolerance band. The value can only be entered as positive value.

Negative tolerance

“Negative tolerance” and the present measurement from Channel 1 form the lower limit for the tolerance band. The value can only be entered as negative value.

Positive hysteresis

If a positive tolerance infringement has occurred, then the present measurement from Channel 2 – 6 must first fall below the measurement from

18 Configuration - Groups

Channel 1 plus the positive tolerance and minus the positive hysteresis for the alarm to be canceled again. The value for the “positive hysteresis” can only be entered as a positive value.

Negative hysteresis

If a negative tolerance infringement has occurred, the present measurement from Channel 2 — 6 first has to rise above the measurement from Channel 1 plus the negative tolerance and plus the negative hysteresis for the alarm to be canceled again. The value for the “negative hysteresis” can only be entered as a positive value.

Example

The principle of initiating an alarm is the same as for the alarm configuration of the individual analog channels.

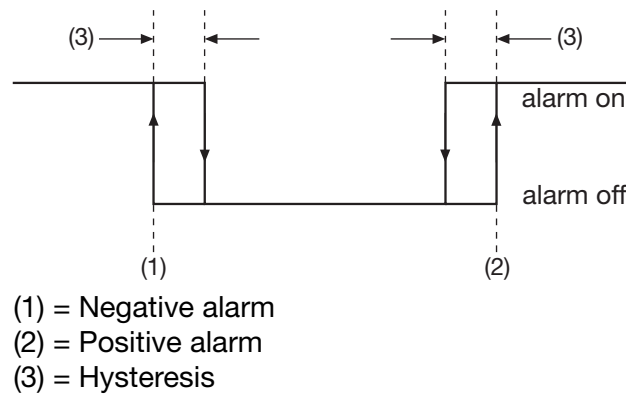

Measurement (Channel 1) = 21 °C

Measurement (Channel 2) = 21 °C, tolerance band comparison is active.

Positive tolerance = 10 °C

Positive hysteresis = 2 °C

An alarm occurs if the present measurement (Channel 2) goes above 31 °C.

The alarm is canceled if the present measurement (Channel 2) falls below 29 °C.

Measurement (Channel 1) = 21 °C

Measurement (Channel 2) = 21 °C, tolerance band comparison is active.

Negative tolerance = -10 °C

Negative hysteresis = 2 °C

An alarm occurs if the present measurement (Channel 2) falls below 11 °C.

The alarm is canceled if the present measurement (Channel 2) goes above 13 °C.

In the example illustrated, Channel 1 is constant and Channel 2 alters its measurement. However, this must not necessarily be so. It can also happen that Channel 1 changes, or even that both channels change.

18 Configuration - Groups

Overview Channel 2 – Channel 6

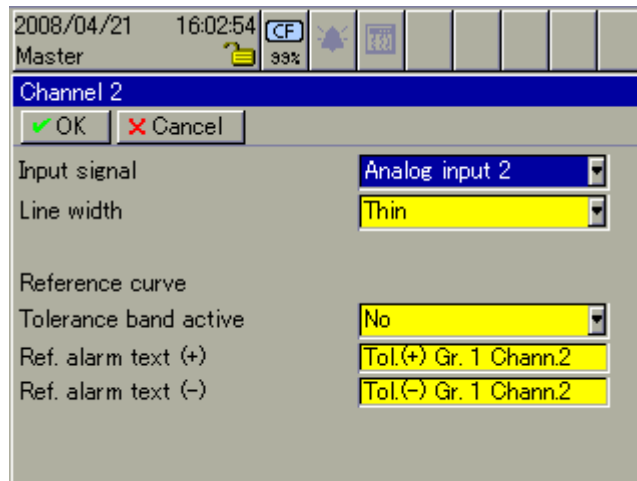

Input signal The input (or input signal) selected here will be used as channel no. 2 – 6 for the group. All internal or external analog channels, as well as math channels (available as an extra), can be chosen.

Line width Determines the width of the graphical measurement display.

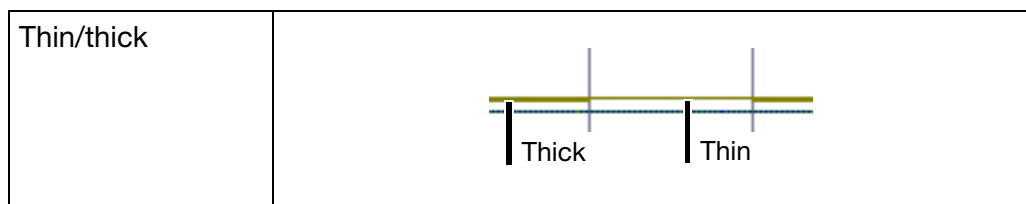

Tolerance band active If this function is active, the channel is compared with Channel 1 of the group.

| | |
|-----|--|
| Yes | Tolerance band comparison is active. Please note that Channel 1 of the group must be active (Input signal <> Inactive). |
|-----|--|

Ref. alarm text (+) The text that was entered (up to 21 characters) is displayed in the “status & title bar” and entered in the alarm or event list if the selected channel leaves the tolerance in the positive direction.

Ref. alarm text (-) The text that was entered (up to 21 characters) is displayed in the “status & title bar” and entered in the alarm or event list if the selected channel leaves the tolerance in the negative direction.

18 Configuration - Groups

18.3 Binary Channels

Overview

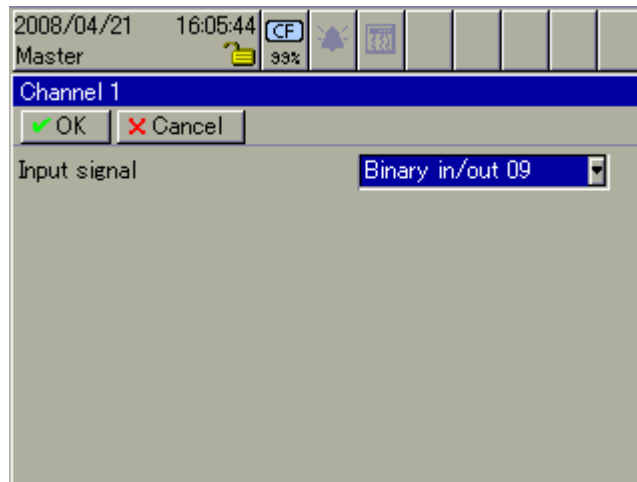

Input signal The binary input/output or signal is selected here that will be used for visualization. Max. 6 binary channels can be visualized and recorded in a group.

18.4 Counters/Integrators

Overview

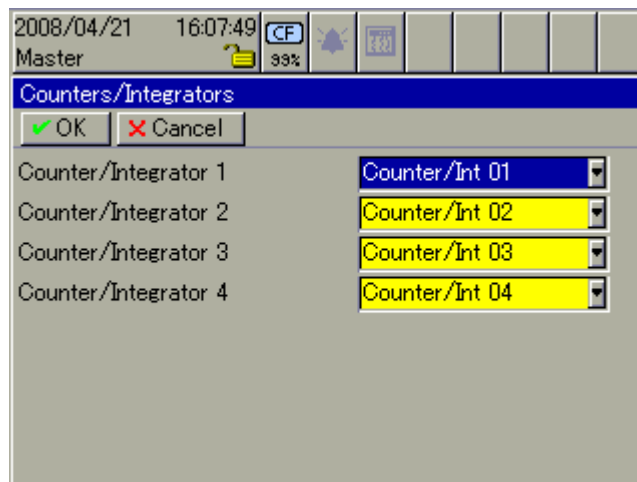

Counters/ integrators (totalizers) Up to 4 out of a total of 27 available counters/integrators can be assigned to the group. As a result of the assignment of the counters to a group, it is possible to allocate the counter and integrator alarms to the batches (plants) and to enter them in the corresponding alarm and event lists.

⇒ Chapter 3.3 "Group and Plant Management (Batches)"

All 27 counters can be read off in each group in the PCA3000 Evaluation software. The four that have been allocated here are normally visible, the remaining ones can be switched into display as required.

18.5 Diagram View

Overview

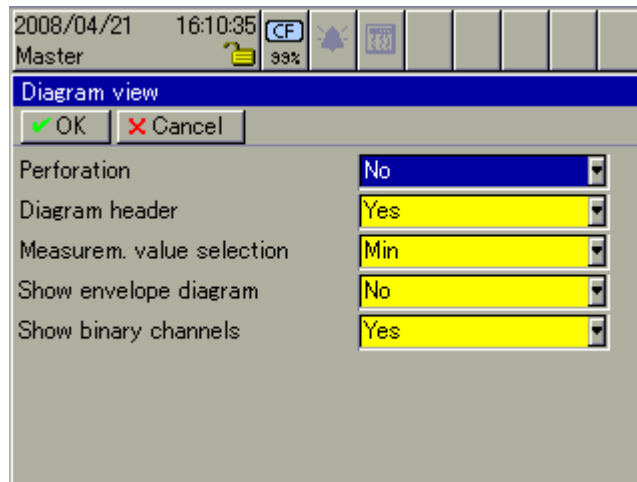

It is also possible to alter some parameters in the visualization

Curves or *Binary* using the  symbol, without having to alter the configuration.

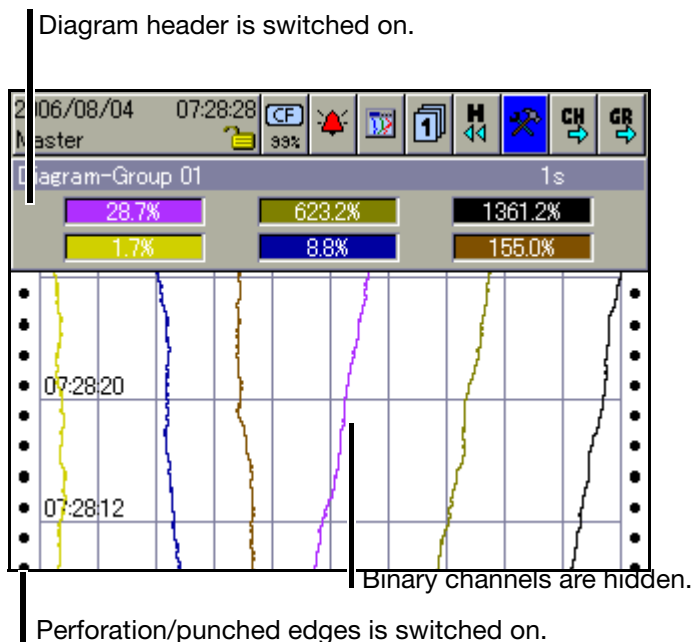

Perforation

If perforation is switched on, then the perforated margin – familiar from chart recorders – appears in the curve display, on the left-hand and right-hand edges of the screen. A precondition for this is, however, that the display of the binary traces is switched out of display.

18 Configuration - Groups

Diagram header With the help of this parameter, the diagram header can be switched on or off. The diagram header (numerical presentation of the measurements or switch symbols for the binary channels) is available in the visualization mode *Curves* and *Binary*.

Measurement selection The parameter Measurement selection enables you to choose between MIN and MAX. This setting exclusively affects the numerical measurement presentation in the visualization mode *Curves*, but only if MIN and MAX values are recorded at the same time. In the case of MIN and MAX value recording, the recorder operates internally at the maximum sampling rate and stores both the measured minimum and measured maximum within the active storage cycle. Measurement selection determines which value is shown in the diagram header.

| | |
|-----|---|
| MIN | Minimum values are displayed in the diagram header. |
| MAX | Maximum values are displayed in the diagram header. |

MIN/MAX value recording is set through the parameter *Stored values* of the operating modes (normal, event and timed operation).

Show envelope diagram This parameter determines whether the measurement curves (only with activated MIN/MAX value recording) are presented as an envelope or as a line in the curve presentation. If the data are not recorded in the MIN/MAX value recording mode, the parameter has no effect.

MIN/MAX value recording is set through the parameter "Stored values = MIN/MAX values" of the operating modes (normal, event and timed operation).

| | |
|-----|--|
| Yes | MIN/MAX values are presented as an envelope. |
| No | MIN/MAX values are presented as a line. |

Show binary channels (traces) This parameter determines whether the binary traces (binary signals) are presented together with the analog signals in the curve display.

| | |
|-----|--------------------------------------|
| Yes | Binary and analog signals are shown. |
| No | The binary signals are not shown. |

18.6 Normal Operation

Overview

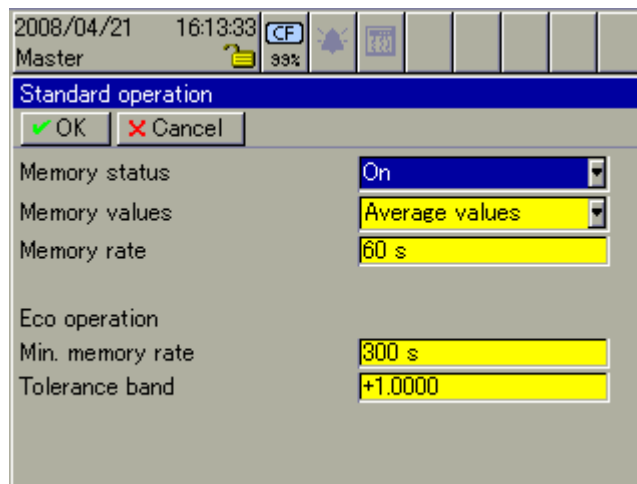

Memory status Only if Memory status is switched on, is the operating mode “Normal operation” available.

With activated normal operation, the measurement data will be recorded at the storage cycle that was configured, unless

- event operation is active,
- timed operation is active or
- the parameter Stored values is configured for Eco mode.





If Memory status is switched off and neither event nor timed operation is active, only events are acquired but no measurement data stored.

Memory values This parameter determines how measurement data are recorded.

| | |
|----------------|--|
| Average values | The average value of the storage cycle that was set is calculated and stored. |
| Current values | The current value is stored at the storage cycle that was set. |
| MIN values | The minimum value is stored at the storage cycle that was set. |
| MAX values | The maximum value is stored at the storage cycle that was set. |
| MIN/MAX values | The minimum and maximum values (envelope) is stored at the storage cycle that was set. |

18 Configuration - Groups

| | |
|----------|---|
| Eco Mode | <p>Using this method, the value is stored if the measurement differs by a certain amount from the value that was last stored, or if a binary channel belonging to the group alters its state.</p> <p>In Eco mode, the configured storage cycle is regarded as the maximum storage rate. In no case will values be stored any faster, even if they change faster. The momentary value is always used for investigating the tolerance band, and only at the instances of time of the storage rate that was configured.</p> <p>⇒ Chapter 2.8.2 "Eco mode"</p> <p>If a measurement is saved in Eco mode, it will, at the same time, be used as the new reference.</p> <p> If the storage cycle is set to 0 (= 125msec), then not 1 measurement but 8 will be stored.</p> <p> If the "Min. storage cycle" is smaller than the "storage cycle", Eco mode will become ineffective, i.e. the momentary values are stored.</p> |
|----------|---|

Memory rate (storage cycle)

The storage cycle is set here. Depending on the setting for the parameter *Stored values*, the measurement data are saved after the set time has elapsed. The smaller the storage cycle, the more data must be saved.



If 0 is set, the recorder uses the fastest possible rate, i.e. it saves the measurements every 125msec (high-speed mode).

Min. memory rate (Eco mode)

The storage cycle is set here, that will only be used if Eco mode is active. If no signal changes occur in Eco mode, no measurement data will be saved. This parameter is used for forced storage at the rate that was set. This provides the additional security that the connected sensing system is functioning.

Tolerance band (Eco mode)

The tolerance for Eco mode is specified here. If, in Eco mode, the deviation of the present value from the value that was last stored is larger than the tolerance entered here, the present value will be stored (if the storage cycle has elapsed at the same time). The tolerance always refers to the current scaling of an analog channel within the current group.

18.7 Event Mode

Overview

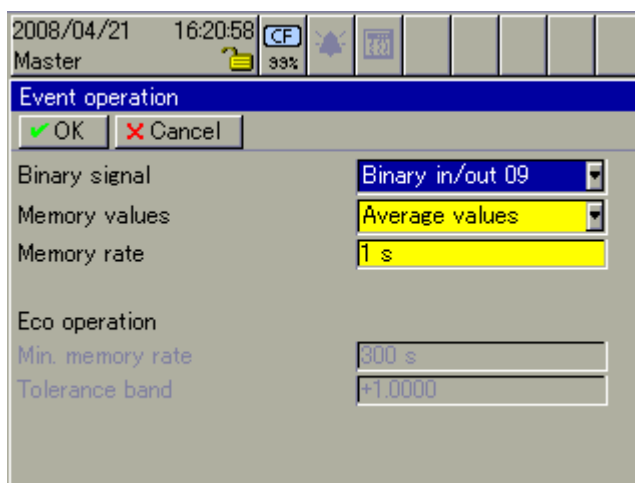

Binary signal Select which signal should start or terminate event operation.

Stored values (memory values) ⇒ Chapter 18.6 "Normal Operation" - Page 133

Storage cycle (memory rate) ⇒ Chapter 18.6 "Normal Operation" - Page 134

Eco mode The parameters for Eco mode are set in the menu *Normal operation*.

18 Configuration - Groups

18.8 Timed Mode

Overview

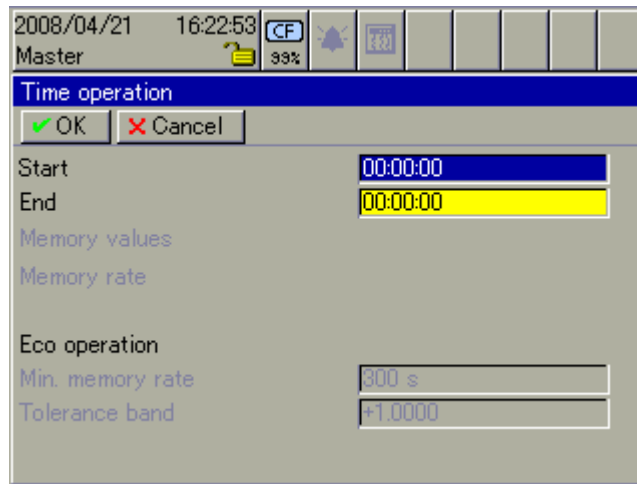

- Start** Start time for initiating timed operation.
If start = end, then timed operation is not active.
- End** Stop time for terminating timed operation.
If start = end, then timed operation is not active.
- Stored values (memory values)** ⇒ Chapter 18.6 "Normal Operation" - Page 133
- Storage cycle (memory rate)** ⇒ Chapter 18.6 "Normal Operation" - Page 134
- Eco mode** The parameters for Eco mode are set in the menu *Normal operation*.

19 Configuration Report

A report can be generated for each of the 9 groups . You can store the MAX/ MIN or average value for each analog channel in a report.



Procedure if the configuration is altered

All reports are concluded, saved and restarted. The values of the concluded reports are set to “----” in the instrument. In this case, the result of the concluded reports can only be made visible through the PCA3000 software.



Procedure in the *Memory manager*

The function “*Save all + update CF*” saves all reports, but does not conclude them. They keep on running.



Automatic interim status of the reports “Total” and “Yearly”

The reports “Total” and “Yearly” are saved once a month, always at the turn of the month, independently of the other reports. They are not concluded, but keep on running.

19.1 Total ... Period

Overview

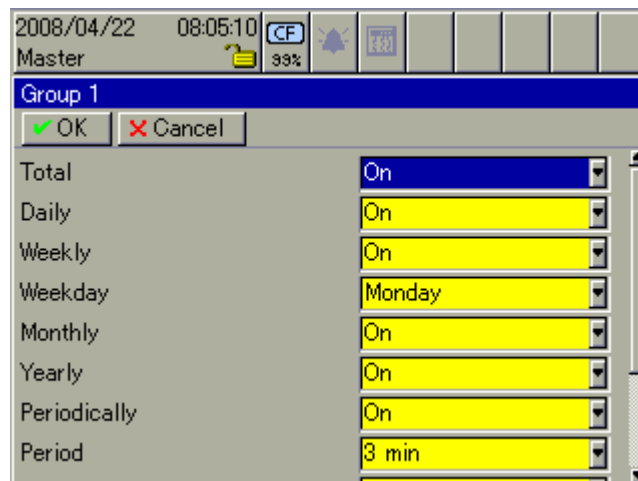

19 Configuration Report

Total *Total* determines whether a report is run over the entire duration of the current recorder configuration.

| | |
|----|--------------------------|
| On | The total report is run. |
|----|--------------------------|

Daily *Daily* determines whether a report is run over one day (24 hours). Conclusion and restart are determined by the parameter *Synchronization time*.

| | |
|----|--------------------------|
| On | The daily report is run. |
|----|--------------------------|

Weekly *Weekly* determines whether a report is run over one week. Conclusion and restart are determined by the parameter *Weekday* and *Synchronization time*.

| | |
|----|---------------------------|
| On | The weekly report is run. |
|----|---------------------------|

Weekday *Weekday* is used for the weekly report, together with the parameter *Synchronization time*, for the report end and restart.

Monthly *Monthly* determines whether a report is run over one month. Conclusion and restart will occur on the first day of the month at 00:00 hours.

| | |
|----|----------------------------|
| On | The monthly report is run. |
|----|----------------------------|

Yearly *Yearly* determines whether a report is run over a whole year. Conclusion and restart will occur on the first day of the year at 00:00 hours.

| | |
|----|---------------------------|
| On | The yearly report is run. |
|----|---------------------------|

Periodic *Periodic* determines whether a periodic report is run. Conclusion and restart are determined by the parameter *Period* and *Synchronization time*.

| | |
|----|-----------------------------|
| On | The periodic report is run. |
|----|-----------------------------|

Period *Period* is used for the periodic report, for the report end and restart.

19.2 External ... Out of range

Overview

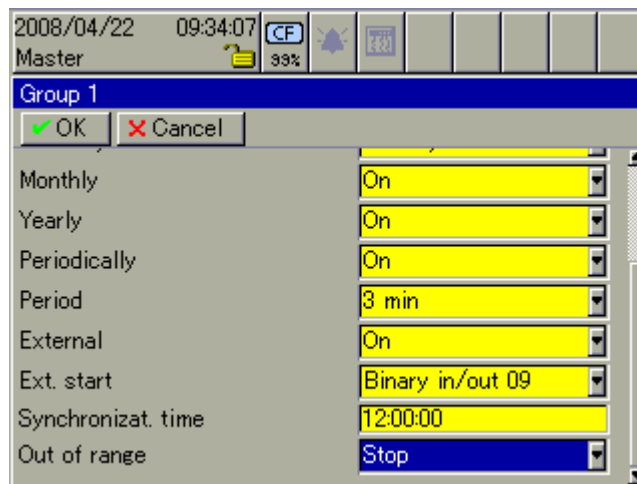

External

External determines whether an external report is run while the external signal (*External start*) is set (HIGH).

| | |
|----|-----------------------------|
| On | The external report is run. |
|----|-----------------------------|



Only one external report will be started in a group within 5 seconds, i. e. any external restart before the 5 seconds have elapsed will be ignored. If the start signal is still present after 5 seconds, the external report will be started at once. If the start signal is no longer present, the report will not be restarted.

External start

External start defines the start signal for the external report.

19 Configuration Report

Synchronization time *Synchronization time* is used for the daily, weekly and periodic report, for the report end and restart.

The parameter *Synchronization time* is explained below, using a period report as an example.

Stop and restart will occur at the next instant of time which fits into the time grid, dependent on the *Synchronization time* and *Period*.

Example:

Period = 2 hours
Synchronization time = 11:30:00
Power ON = 09:11:00

1. Period 1 from 09:11 to 09:30 = 19 minutes
 2. Period from 09:30 to 11:30 = 2 hours
 3. Period 3 from 11:30 to 13:30 = 2 hours
- etc.



The principle is identical for all reports that are dependent on the *Synchronization time* (daily, weekly and periodic report).

As a rule, in the case of the daily report, the first report will not be run for 24 hours, and, in case of the weekly report, not for 7 days.

Out of range „Out of range“ determines what happens when an internal or external analog input, or an allocated math channel, is outside the valid measurement range (scaling).

| | |
|--------|---|
| Stop | The channel reports are stopped. When the measurements are within the range limits again, they will continue to be run. |
| Delete | The reports are set to invalid (“-----”) and will be restarted only after the configured report end has elapsed. |

20 Configuration - Limit Monitoring

Nine limit values are available for limit monitoring, in addition to the alarms at channel level.

For a description of the alarms at channel level, see Chapter 13.4 "Alarm configuration".

20.1 Function ... Alarm Configuration

Overview

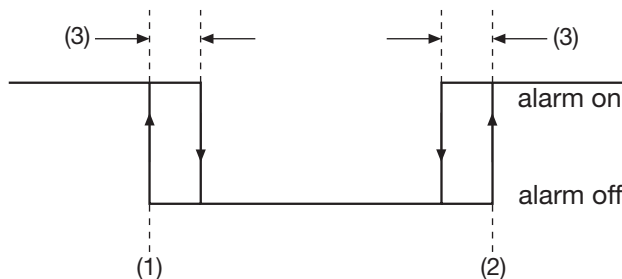
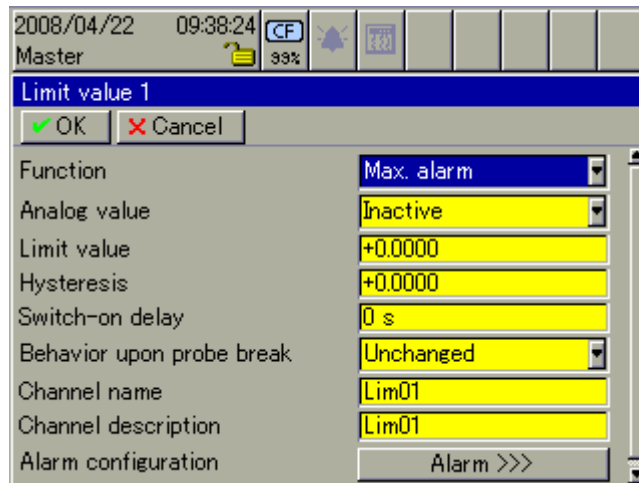

- (1) = Low alarm (limit value)
 (2) = High alarm (limit value)
 (3) = Hysteresis

Function

“Low alarm” and “High alarm” are available for each limit value.

| | |
|------------|---|
| Inactive | Limit monitoring is switched off. |
| Low alarm | Binary signal “Limit monitoring 1 – 9” is activated when the value falls below the limit. |
| High alarm | Binary signal “Limit monitoring 1 – 9” is activated when the value goes above the limit. |

Analog value

Analog value determines the internal or external analog input that is to be monitored.

20 Configuration - Limit Monitoring

| | | | | | | | |
|-----------------------------------|---|-----|--|----|--|-----------|--|
| Limit value | Limit at which the binary signal is activated. | | | | | | |
| Hysteresis (differential) | The hysteresis serves to prevent an unsteady (flickering) binary signal (repeated, brief switching on or off due to the noise of the input signal. The higher the value, the larger the amount by which the present measurement must go above or below the limit in order to cancel the alarm. | | | | | | |
| Switch-on delay | This parameter delays the setting of the binary signal. If the limit infringement is no longer present after the alarm delay time has elapsed, the binary signals will not be triggered. | | | | | | |
| Behavior upon probe break | This parameter defines what will happen to the binary signal in the event of a probe break. <table border="1"><tr><td>Off</td><td>The binary signal is inactivated, irrespective of the present state.</td></tr><tr><td>On</td><td>The binary signal is activated, irrespective of the present state.</td></tr><tr><td>Unchanged</td><td>The binary signal retains its present state.</td></tr></table> | Off | The binary signal is inactivated, irrespective of the present state. | On | The binary signal is activated, irrespective of the present state. | Unchanged | The binary signal retains its present state. |
| Off | The binary signal is inactivated, irrespective of the present state. | | | | | | |
| On | The binary signal is activated, irrespective of the present state. | | | | | | |
| Unchanged | The binary signal retains its present state. | | | | | | |
| Channel name (designation) | Short designation for the binary signal, up to 7 characters. The channel name is displayed in the individual visualization modes, together with the channel designation. | | | | | | |
| Channel description | Description of the binary signal, up to 21 characters. The channel description is displayed in the individual visualization modes, together with the channel name. | | | | | | |
| Alarm configuration | Opens the submenu for the configuration of the alarm. | | | | | | |

20 Configuration - Limit Monitoring

20.2 Alarm Configuration

Overview

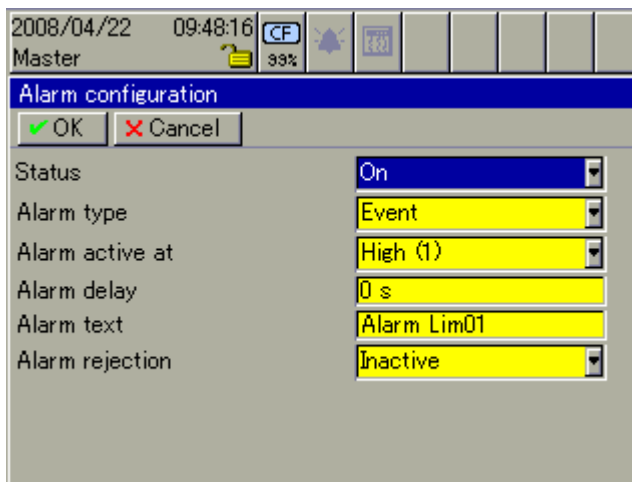

Status

Status activates alarm monitoring.

| | |
|-----|---|
| Off | Alarm monitoring is not active. |
| On | Alarm monitoring is active. In the event of an alarm, the binary signal “Alarm Limit 1 – 9” is set in addition to the binary signal “Limit monitoring 1 – 9”. |

Alarm type

The alarm type determines whether the activating/inactivating of a binary signal is to be evaluated as a genuine alarm or only as an event.

| | |
|-------|--|
| Event | The alarm text is entered in the event list only. |
| Alarm | The alarm text is entered in the alarm list and the event list. In addition, the alarm text appears in the “status & title bar”, and the alarm bell is shown in red.  <p style="text-align: center;"> Alarm text Alarm bell </p> |

Alarm active on

Determines whether the alarm is present with active or inactive limit infringement.

| | |
|----------|---|
| High (1) | Alarm with active limit infringement. |
| Low (0) | Alarm with inactive limit infringement. |

20 Configuration - Limit Monitoring

- Alarm delay** This parameter delays the reporting of an alarm. If the alarm is no longer present after the alarm delay time has elapsed, it will not be triggered.
- Alarm text** Text that is entered in the event or alarm list and displayed in the “status & title bar”, with the alarm type “Alarm”.
- Alarm rejection** This function makes it possible to suppress alarms when a binary signal is active (HIGH state).
- Both alarm types (alarm and event) are suppressed.
 - Alarms that are present become inactive.
 - There is no alarm or event entry when alarm rejection is active.

21 Configuration - Counters/Integrators

Each of the 27 channels can be configured as a counter, integrator, operating time counter, high-speed counter, or for measuring flow rates in combination with high-speed counters.

- Counters (counting frequency 8Hz) are used to count binary signals.
- Integrators are used to integrate analog inputs.
- Operating time counters are used to measure the time in which binary signals are active.
- High-speed counters (counting frequency 10kHz) are used to count the pulses of the first two binary inputs of a module (B1, B2, B9, B10, B17, B18). If a module has not been fitted with binary inputs, then the high-speed counters cannot be used for this module.
- The flow rate quantity is used together with high-speed counters to measure flow rate.

Stored counter and integrator counts (except for the flow rate quantity) can be evaluated on a PC using the PCA3000 Evaluation software. The counter/integrator count that was last stored can be displayed in the *Visualization* menu using function *Counters/integrators*.



Please observe the notes in Chapter 2.5.

21.1 General Setting

Overview

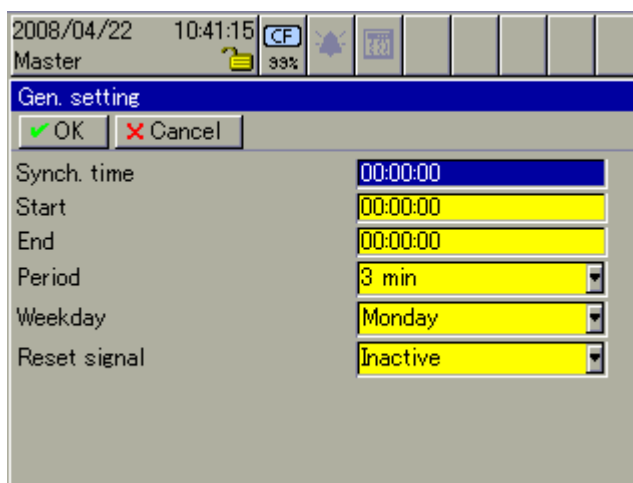

Synch. time

Synchronization time is used for daily, weekly and periodic counters and integrators, for termination and restart. When the synchronization time has been reached, all counts are stored, and the function is restarted with the start value 0.

For the “weekly” type, the parameter *Weekday* is also relevant.

The parameter *Synchronization time* is explained below, using a periodic counter by way of example.

21 Configuration - Counters/Integrators

Stop and restart will occur at the next point in time which fits into the time grid, dependent on the *Synchronization time (Synch. time)* and *Period*.

Example:

Period = 2 hours
Synchronization time = 11:30:00
Power ON = 09:11:00

1. Period 1 from 09:11 to 09:30 = 19 minutes
 2. Period 3 from 09:30 to 11:30 = 2 hours
 3. Period from 11:30 to 13:30 = 2 hours
- etc.

Start *Start* is the start time for counters or integrators which have the parameter *Type* configured for “Daily (start...end)”.

End *End* is the end time for counters or integrators which have the parameter *Type* configured for “Daily (start...end)”.

Period *Period* is the period length for counters and integrators which have the parameter *Type* configured for “Periodic”.

Weekday On *Weekday* at the *Synchronization time*, counters and integrators which have the parameter *Type* configured for “Weekly” are stored and restarted with the start value 0.

Reset signal In addition to the normal end, a signal can be determined here with which the counter/integrator counts can be set to 0.



The current states are not stored. This function proves useful for setting up a plant (test run), for instance.

Note



The „General Setting“ can be taken out of effect for each counter/integrator with a specific setting.

21 Configuration - Counters/Integrators

21.2 Function ... Specific Setting

Overview

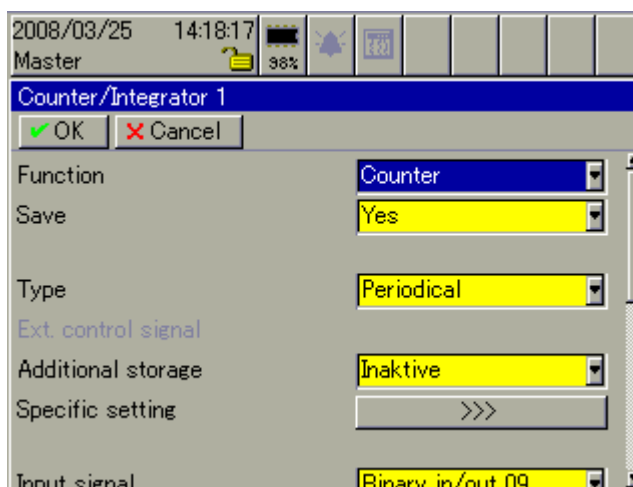

Function

Function determines whether the channel that was selected will be used as a counter integrator, operating time counter, high-speed counter, or for flow rate measurements.

| | |
|-------------------------------|--|
| Counter | The binary signal will be counted. |
| Integrator | The analog signal will be integrated. |
| Operating time | The operating time will be acquired using a previously set binary signal. |
| High-speed counters B1 – B18 | One of up to 6 fast binary inputs will be recorded (B1, B2, B9, B10, B17, B18). Depending on the module equipment level, not all high-speed counters may be available. |
| Flow rate quantity B1 ... B18 | One of up to 6 fast binary inputs will be used to measure flow rate quantity (B1, B2, B9, B10, B17, B18). Depending on the module equipment level, not all binary inputs may be available. |

Save

Save determines whether the event will be saved for the evaluation software PCA3000, i.e. whether it can be evaluated in PCA3000. The parameter and corresponding result are not available in the function Flow rate quantity.

| | |
|-----|--|
| Yes | The counter/integrator count is saved for PCA3000. |
|-----|--|

21 Configuration - Counters/Integrators

Type *Type* determines when the current count is stored. According to the setting, the parameters from Chapter 21.1 "General Setting" must also be taken into account.

| Type | Description |
|---------------------|---|
| Periodic | Conclusion and restart are determined by the parameters <i>Period</i> and <i>Synch. time</i> . |
| External | Conclusion and restart are determined by an <i>ext. control signal</i> . The counters/integrators operate when the external signal is set (HIGH). |
| Daily | <i>Daily</i> defines that the counters/integrators are counted/integrated over one day (24 hours). Conclusion and restart are determined by the parameter <i>Synch. time</i> . |
| Weekly | <i>Weekly</i> defines that the counters/integrators are counted/integrated over one week. Conclusion and restart are determined by the parameters <i>Weekday</i> and <i>Synch. time</i> . |
| Monthly | <i>Monthly</i> defines that the counters/integrators are counted/integrated over one month. Conclusion and restart will occur on the first day of the month at 00:00 hours. |
| Yearly | <i>Yearly</i> defines that the counters/integrators are counted/integrated over one year. Conclusion and restart will occur on the first day of the year at 00:00 hours. |
| Total | <i>Total</i> defines that the counters/integrators are counted/integrated for the entire duration of the current configuration. |
| Daily (start – end) | <i>Daily (start...end)</i> defines that the counters/integrators are counted/integrated over a period within one day. Restart and conclusion are determined by the parameters <i>Start</i> and <i>End</i> . |

The parameter *Type* is not available for measuring the flow rate quantity.

Ext. control signal Selection of the control signal if *Type* "External" has been configured.

Additional storage This parameter determines whether current states should be stored an additional time. "Additional" means: in addition to storage resulting from the *Type* parameter. Current states are stored but are not reset. This parameter is not available for the function Flow rate quantity.

Specific setting This parameter renders the times (not the Reset signal) from Chapter 21.1 "General Setting" ineffective. The parameter is not available for the function Flow rate quantity.

21 Configuration - Counters/Integrators

21.3 Input Signal ... Decimal Place

Overview

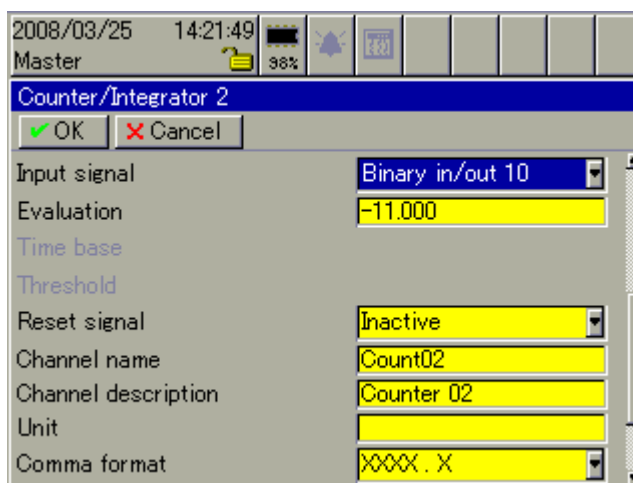

Input signal *Input signal* which will be counted or integrated. If High-speed counter or *Flow rate quantity* was selected for the *Function* setting, Input signal is not available. The assignment cannot be changed.

Weighting (evaluation) For binary signals (counter), each time the signal is set, the result is increased by the *Weighting* factor. With analog signals (integrator), the current measuring value is multiplied by the *Weighting* and added to the result. A down-counter can be formed by a negative weighting. Weighting is not available for the *Function* "Operating time".

Time base With the Integrator function, the current measurement value (with weighting factored in) is integrated according to the time base.

| | |
|--------|---|
| Second | The measurement is divided by 1 and totalized every second. |
| Minute | The measurement is divided by 60 and totalized every second. |
| Hour | The measurement is divided by 3600 and totalized every second. |
| Day | The measurement is divided by 86400 and totalized every second. |

With the Operating time function, the time base determines the unit of measure of the operating time counter.

| | |
|--------|---|
| Second | The operating time is shown in seconds. |
| Minute | The operating time is shown in minutes. |
| Hour | The operating time is shown in hours. |
| Day | The operating time is shown in days. |

21 Configuration - Counters/Integrators

With the function Flow rate quantity, the time base determines the counting duration of pulses (gate time) and display interval.

| | |
|--------|---|
| Second | The flow rate quantity is determined over the course of a second and displayed. |
| Minute | The flow rate quantity is determined over the course of a minute and displayed. |
| Hour | The flow rate quantity is determined over the course of a hour and displayed. |
| Day | The flow rate quantity is determined over the course of a day and displayed. |

Threshold

Threshold value is only available for the *Function* "Integrator". An integration can only be made if the present measurement is larger than the threshold value. Time base and weighting are not considered in the threshold value comparison.

Reset signal

In addition to the normal end, a signal can be specified here that can be used to set the selected counter and integrator count to 0. This parameter is not available for the function Flow rate quantity.



The current status is not saved. The reset is performed in addition to the Reset signal from Chapter 21.1 "General Setting".

Channel name (designation)

Short designation for the counter/integrator, up to 7 characters. The channel name is displayed in the individual visualization modes, together with the channel designation.

Channel description

Description of the counter/integrator, up to 21 characters. The channel description is displayed in the individual visualization modes, together with the channel name.

Unit

Unit of measure in which the counter or integrator count will be displayed, up to 5 characters. The unit is displayed wherever the count is represented numerically.

Decimal place (Comma format)

The decimal place serves to determine the number of integer and decimal places for the numerical representation of counter states. If required, the instrument will automatically switch to a different format, in order to be able to show all the integer places. As a rule: all integer places must be displayed.

21 Configuration - Counters/Integrators

21.4 Range Start ... Alarm Configuration

Overview

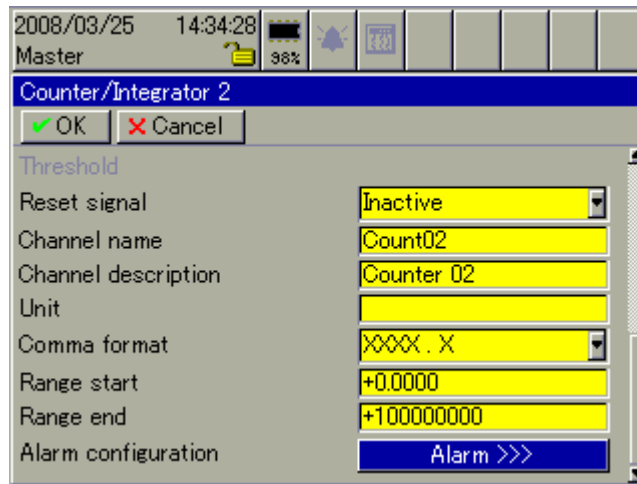

Range start and range end

Range start and range end determine the lower and upper limit of the bar graph display.

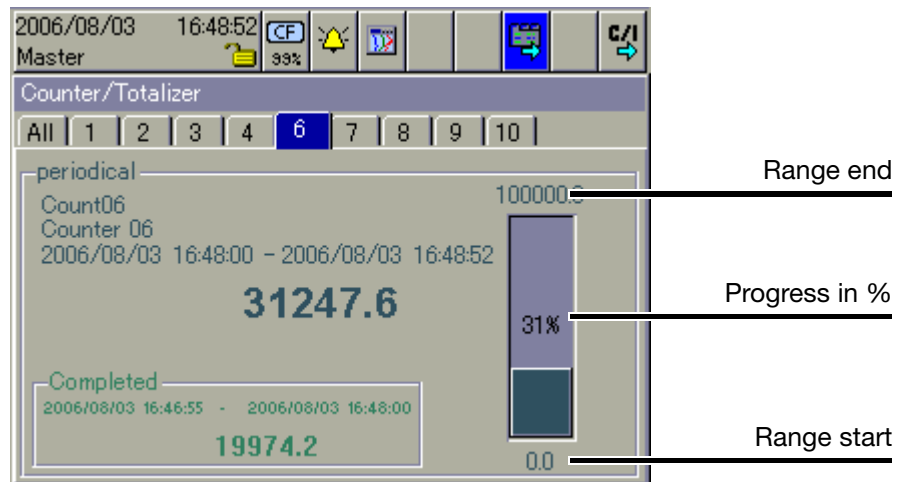

Counters/integrators are represented with a maximum of 9 digits. At overflow that restart at 0.0.

Alarm configuration

Opens the submenu for the configuration of both alarms.

21 Configuration - Counters/Integrators

21.5 Alarm Configuration

Overview

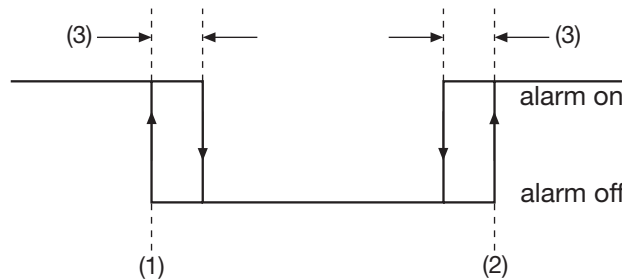
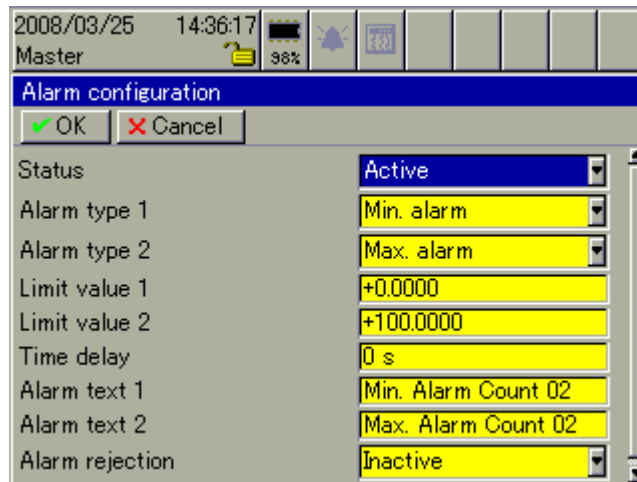

- (1) = Low alarm (limit value 1)
- (2) = High alarm (limit value 2)
- (3) = Hysteresis

Status

Status activates alarm monitoring.

| | |
|-----|---------------------------------|
| Off | Alarm monitoring is not active. |
| On | Alarm monitoring is active. |

Alarm type 1/ alarm type 2

“Low alarm” and “High alarm” are available for each alarm type.

| | |
|------------|---|
| Low alarm | Alarm is initiated if the value has fallen below the limit. |
| High alarm | Alarm is initiated if the value has gone above the limit. |

Limit value 1/ limit value 2

Limit at which the alarm is initiated.

Time delay

This parameter delays the reporting of an alarm. If the alarm is no longer present after the time delay has elapsed, it will not be triggered.

Alarm text 1/ alarm text 2

There is an alarm text for each alarm type, which, in the event of an alarm, is displayed in the “status & title bar” and entered in the alarm and event list.

21 Configuration - Counters/Integrators

Alarm rejection This function makes it possible to suppress alarms when a binary signal is active (HIGH state).

- Both alarm types (alarm and event) are suppressed.
- Alarms that are present become inactive.
- There is no alarm or event entry when alarm rejection is active.

21 Configuration - Counters/Integrators

22 Configuration - Interface

The interfaces are used by the paperless recorder to communicate with other systems (e. g. a PC that is running the setup program or the PCA communications software).



A detailed description of the entire range of interface functions and protocols can be found in the separate interface description 59494.

Overview

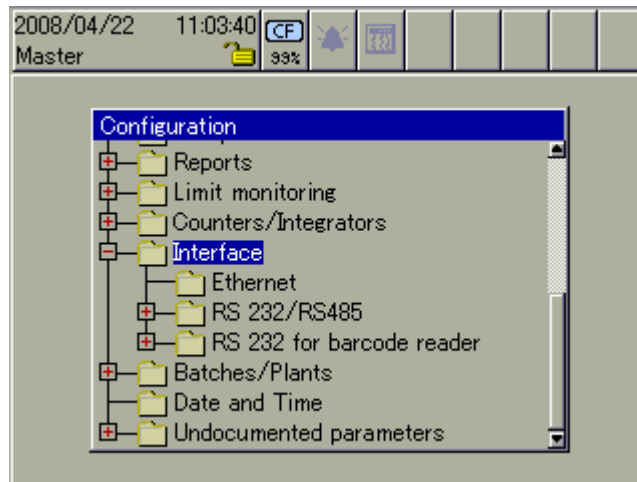

The interfaces for Ethernet (connector 6) and RS232/RS485 (connector 7) and the “RS232 for barcode reader” (connector 2) are provided as standard in the recorder.



- A barcode reader can also be connected to the RS232/RS485 interface.
- The “RS232 for barcode reader” interface can also be used for the transfer of data between the PC and a paperless recorder.
- Two barcode readers can be connected to 2 interfaces. The strings that are read in are fed to the same evaluation function. So it is conceivable that, for instance, one reader is used to start a batch report, and another reader to stop it.
- Only one modem can be connected.



In addition to the configurable interfaces described in this chapter, the paperless recorder is also fitted with a special setup interface. It is also possible to run the setup program and the PCA communications software through these setup interfaces. There is one on the back panel (connector 5) and one on the front panel of the instrument (but not on the stainless steel version). The connection between the PC and the recorder is made via a PC interface with a TTL/RS232 converter, or a PC interface with an USB/TTL converter.

22 Configuration - Interface

22.1 Ethernet

The Ethernet interface can be used to connect the paperless recorder to a network. Communication is designed for 10Mbit/sec and 100Mbit/sec, and the network connection is made through an RJ45 socket.

Overview

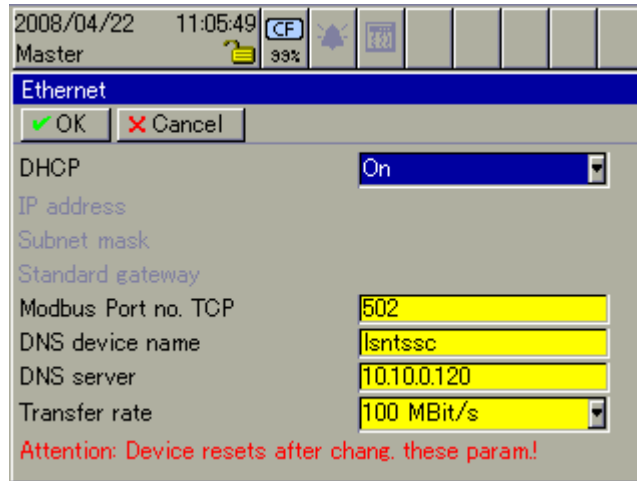

All settings that affect the Ethernet must be cleared with the responsible network administrator. A maximum of four users are permitted access to a paperless recorder simultaneously.

If alterations are made to the settings for Ethernet parameters, then the instrument will automatically carry out a reset (restart).

DHCP

DHCP (Dynamic Host Configuration Protocol) is used so that the paperless recorder can automatically receive an IP address and other communication parameters from a DHCP server.

| | |
|----|--|
| On | DHCP is switched on, the recorder receives its IP address from the DHCP server |
|----|--|

The other communication parameters that the paperless recorder usually receives from the DHCP server include the subnet mask, gateway address, and the lease time.

When the lease time (user time) has expired, the IP address loses its validity. In order that the paperless recorder may always have a valid IP address, it sends a query to its DHCP server whether the address is still valid when 50% of the lease time has expired. If the DHCP server is not available, the recorder repeats the query until 87.5% of the lease time has expired. After that, the recorder sends the query not only to the DHCP server, but to the entire network. If the lease time expires without the IP address being confirmed, the recorder declares the address as invalid and is no longer accessible in the network.

22 Configuration - Interface



An assigned address can be altered by the DHCP server. If, for example, the PCA communication software is used for the automatic collection of data, then the address must be altered within the software.

The automatically assigned IP address can be read in the menu *Device manager* → *Device info* → *Eth. Info* (Chapter 8.3 "Device information").

| | |
|----------------------------|--|
| IP address | If automatic IP address assignment is not used (DHCP = OFF), then the IP address for the paperless recorder is set here. |
| Subnet mask | <p>If automatic IP address assignment is not used (DHCP = OFF), then the subnet mask is set here.</p> <p>The subnet mask is used to gather devices (PC, recorders etc.) together to form subnets. All devices that have an IP address that is AND linked to the subnet mask belong to one subnet and can communicate with one another.</p> <p>If it is necessary to access devices outside the subnet, then the communication must be handled by a gateway (standard gateway).</p> |
| Standard gateway | <p>If automatic IP address assignment is not used (DHCP = OFF), then the address of the standard gateway is set here.</p> <p>The standard gateway is used for communication with devices that do not belong to the subnet.</p> |
| Modbus port no. TCP | <p>The port address must be set for access to the paperless recorder and Modbus TCP protocol with visualization software is used (Modbus tunneling: outer frame Ethernet, inner frame Modbus).</p> <p>⇒ Further information can be obtained from the Operating manual 59484</p> |
| DNS device name | The DNS device name is set here. This makes it possible to access the device not only through its IP address, but also through its name. |
| DNS server | This is used to set up the IP address for a DNS server that is installed in the network. The DNS server is required to resolve the name for e-mail transfer via Ethernet. |
| Transfer rate | Here you can configure the transfer rate that is used for communication between the paperless recorder and the DHCP server or other computers. |
| Web server | <p>The paperless recorder has an integrated web server to operate the instrument via the Ethernet interface.</p> <p>⇒ Chapter 27 "Web server"</p> |

22 Configuration - Interface

22.2 RS232/RS485

22.2.1 General

Overview

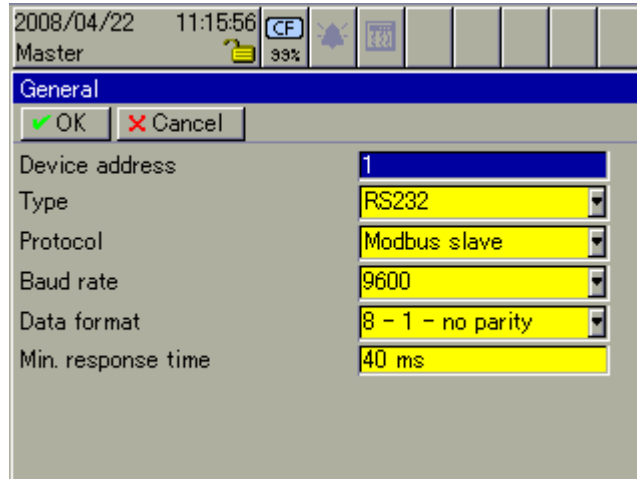

In order for communication to take place – e. g. with the setup program – the interface parameters for the PC and the recorder must be identical at both ends of the connection.

Device address For the RS485 type of interface, the *device address* for the paperless recorder must only occur once within a group of connected instruments on the same bus. This has little significance for an RS232 interface, since only one device can be connected to the serial interface.

Type The type of interface that is to be used.

Protocol The protocol that is to be used.

| | |
|---------------|--|
| Modbus slave | The paperless recorder operates as a Modbus slave. |
| Modbus master | The paperless recorder operates as a Modbus master. Additional parameters must be set up in the menu <i>Device manager</i> → <i>Configuration</i> → <i>Interface</i> → <i>RS232/RS485</i> → <i>Modbus master</i> . |
| Bar code | A barcode reader is to be connected to the interface. |

⇒ Further information can be obtained from the Operating manual 59484

Baud rate The transmission rate that is to be used for operating the interface.

22 Configuration - Interface

Data format The data format that is to be used for operating the interface.

| | |
|---------------------|--------------------------------------|
| 8 - 1 - no parity | 8 data bits, 1 stop bit, no parity |
| 8 - 1 - odd parity | 8 data bits, 1 stop bit, odd parity |
| 8 - 1 - even parity | 8 data bits, 1 stop bit, even parity |

Min. response time The *minimum response time* is the minimum time that the recorder will take before it sends a response to a data request.

The minimum response time is required by the RS 485 interface in the master, in order to switch over the interface driver from transmit to receive. This parameter is not required for the RS 232 interface.

22.2.2 Modbus master

Overview

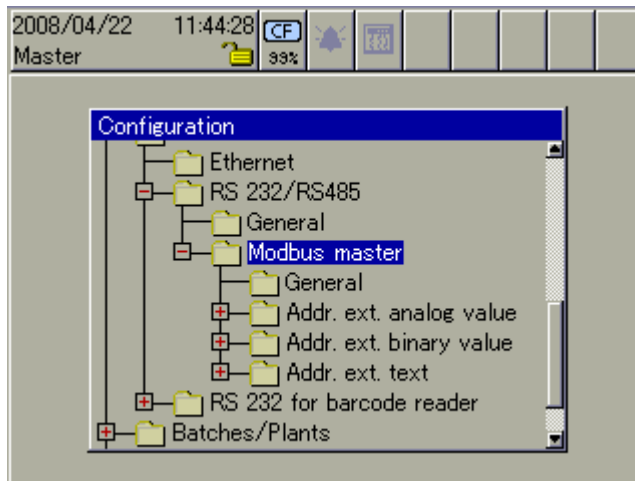

The parameters found under *Modbus master* can only be set up if the Modbus master was selected as the protocol in the RS232/RS485 interface settings.

General The *timeout* and *polling cycle* are set here. The *timeout* defines that time after which the master will declare that an initiated request has an error. The *polling cycle* defines the interval between requests for reading data from a slave device.

Addr. ext. analog value A maximum of 24 external analog inputs can be read into the paperless recorder. The following parameters must be configured for each analog variable.

| | |
|----------------|--|
| Device address | The address of the slave device from which data are to be fetched. |
| Modbus address | Address within the instrument. The entry is made in decimal format. ⇒ See the instrument documentation for the slave device. |

22 Configuration - Interface

| | |
|------------------------|---|
| Number of measurements | The number of measurements to be read. The number "1" means that one measurement is made at every cyclical interval. If a number larger than 1 is entered, then (commencing at the Modbus address) several measurements will be read and automatically distributed to the following external inputs (analog values). The entry template will be locked for subsequent values. Example: starting at "Ext. analog value1", three measurement values are read. In the menu, the settings for "Ext. analog value 2" and "Ext. analog value 3" are locked. starting at "Ext. analog value 4", a new arrangement can be configured. |
| Data format | Selection of the format in which data are to be received. For the float format, you can define whether the LSB (least significant bit) or MSB (most significant bit) is transmitted first. In the unsigned integer format (UInt: 0 – 65535) and the integer format (Int: -32768 – 32767) you can define a divisor for the division of the data that are received. The purpose of the division is to make it possible for floating point values to be transmitted in integer format. So the sender must multiply the data by the corresponding factor before transmission. |

Addr. ext. binary value

A maximum of 24 external binary tracks (binary values) can be read into the paperless recorder. The following parameters must be configured for each binary variable.

| | |
|----------------|--|
| Device address | The address of the slave device from which data are to be fetched. |
| Modbus address | Address within the instrument. ⇒ See the instrument documentation for the slave device. |
| Bit number | The bit (b0 – b15) that is to be read. ⇒ See the instrument documentation for the slave device. |
| Bit quantity | The number of bits to be read. The number "1" means that one bit is read at every cyclical interval. If a number larger than 1 is entered, then (commencing at the Modbus address) several bits will be read and automatically distributed to the following external binary values. The entry template will be locked for subsequent values. Example: starting at "Ext. binary value 1", 16 bits are read. In the menu, the settings for "Ext. binary value 2" to "Ext. binary value 16" are locked. starting at "Ext. binary value 17", a new arrangement can be configured. |

22 Configuration - Interface

Addr. ext. text A maximum of 9 texts can be read into the paperless recorder.

| | |
|----------------|---|
| Device address | The address of the slave device from which data are to be fetched. |
| Modbus address | Address within the instrument. ⇒ See the instrument documentation for the slave device. |
| Word number | The read-in is always made as words, i. e. there will always be at least two characters read. |

22.3 RS232 for Barcode Reader

Overview

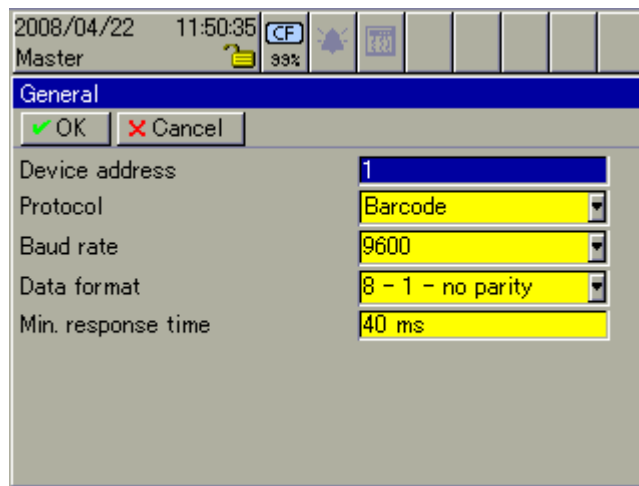

The settings correspond to those for the interface „RS232/RS485“.

⇒ Chapter 22.2 "RS232/RS485"



The transmission rate at which the barcode reader operates can be found in the operating manual for the barcode reader. In many cases, the maximum transmission rate will be 9600 bps.

The barcode reader can be used to start batches and for the automatic entry of batch data.

⇒ Chapter 23 "Configuration – Batches/Plants"

22 Configuration - Interface

23 Configuration – Batches/Plants

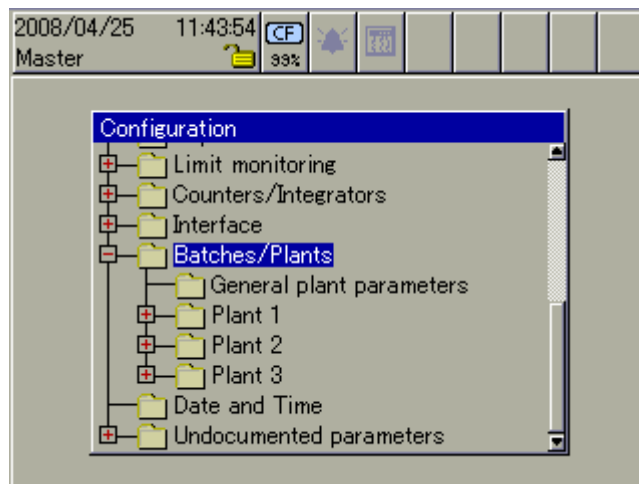

 Please note the relationship between group and plant (batch).
⇒ Chapter 3.3 "Group and Plant Management (Batches)"

 ⇒ The visualization of batches (in progress and completed) is described in Chapter 4.9 "Batches/Plants".

23.1 General Information on Batches

Batch reporting enables the creation of a flexible form to describe a batch process within the paperless recorder. A maximum of three batches (for 3 plants) can be recorded at the same time.

The control (start, stop) of the batch reports can be performed by one of the binary signals (control signals), by the control knob, or by a barcode reader.

For additional information on the digital signals, see

⇒ Chapter 2.7 "Binary Signals"

For additional information on control by a barcode reader, see

⇒ Chapter 4.9.3 "Batch Control with Barcode Reader"

Two different screen presentations are available for batch reporting: The following are available:

- current batch report and
- completed batch report

23 Configuration – Batches/Plants

Batch texts How can something be edited?

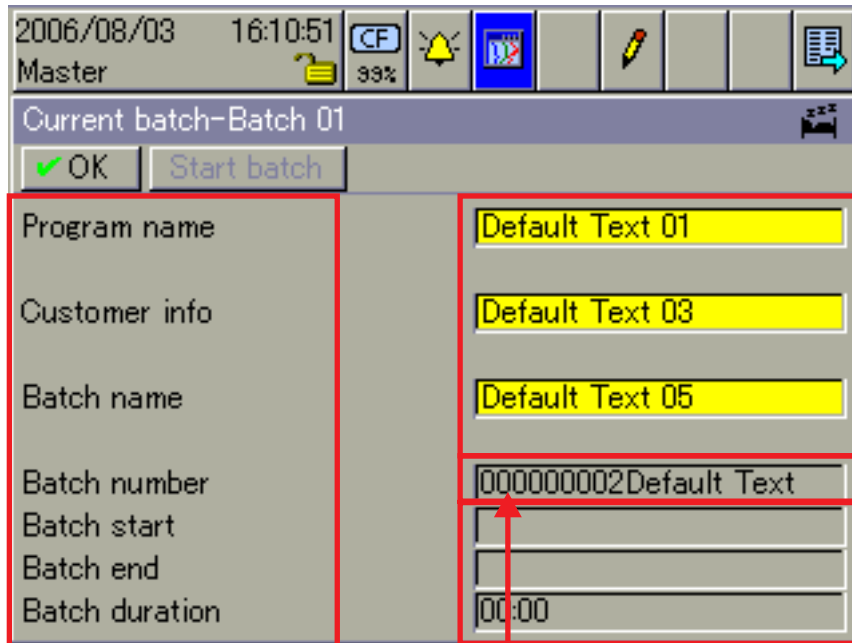

Texts can be edited on the device and with the setup software. They can also be sent to a device “online” with the setup software.

- Device:**
- Configuration
 - Batches/plants
 - Plant 1...3
 - Line 1..10
 - Content of right column and factory setting

- Device¹**
- Visualization
 - Current batch
 - Select batch
 - Activate editing
 - Select field with control knob
 - Activate control knob

- Setup software:**
- Batches/plants
 - Batches/plants 1...3
 - Batch information
 - Select line
 - Edit

- Setup software (online):^{1,2}**
- Set up connection
 - Extras (tools)
 - Write interface texts
 - Edit texts
 - Send

Texts can be edited on the device and with the setup software.

- Device:**
- Configuration
 - Batches/plants
 - Gen. batch parameters
 - Text of left column 1...10

- Setup software:**
- Batches/plants
 - Batches/plants 1
 - Batch information
 - Lines 1...10
 - Edit

If batch start, end and duration are used, the lines cannot be edited.

The batch number can be permanently changed only on the device (Parameterization menu).

It can be temporarily changed¹ on the device or with the setup program. At the end of a batch, the device-internal batch number is incremented and reactivated.

¹ Only available if the relevant batch parameter “Text editable” is set to Yes.

² If recording of interface texts does not work, the user who is connected with the device does not have the necessary rights.

23 Configuration – Batches/Plants

23.2 General Plant Parameters

Overview

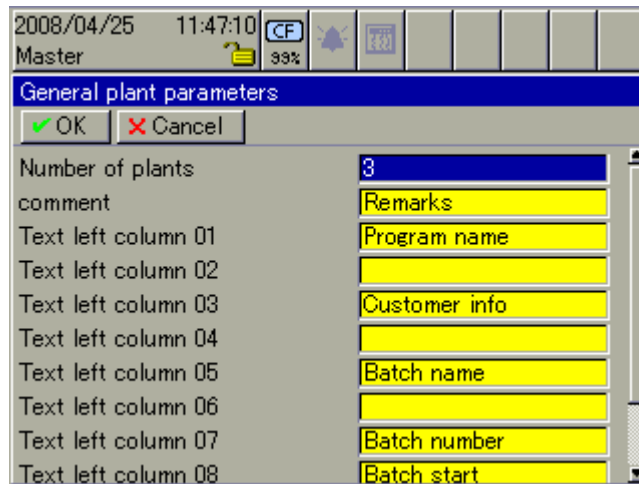

Number of plants

The parameter defines the number of plants for which a batch report will be created.

| | |
|---------|--|
| 0 | Batch reporting is not active. |
| 1 ... 3 | A batch report is created for each active plant. |

Comment

For concluded batches, the text that is entered is shown as a header for a text of maximum length 400 characters, which is used to describe the batches (recipe or similar).



The description cannot be entered on the device. Instead it must be entered using the setup program or an interface (web server or Modbus).

Text left column 01 – 10

The parameters define the text in the left-hand column of the batch protocol. The text is the same for all plants (batch reports).

⇒ Chapter 4.9 "Batches/Plants"

23 Configuration – Batches/Plants

23.3 Plant 1 – 3

Overview

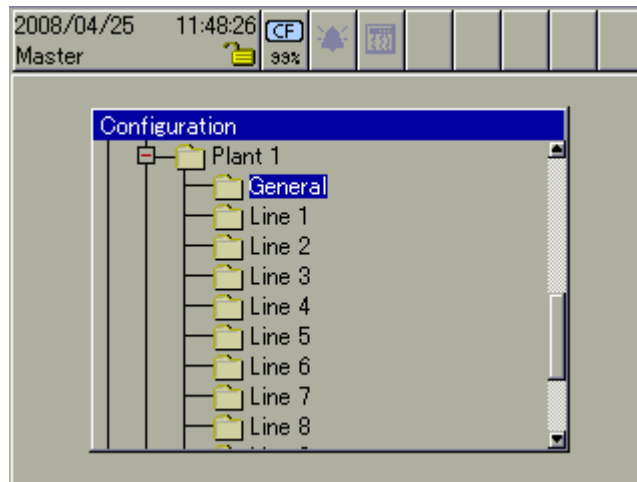

For each plant/batch, in addition to the “general plant parameters”, there are also some “general parameters” and the management of the contents in the right-hand column of the batch reports.

23.3.1 General

Overview

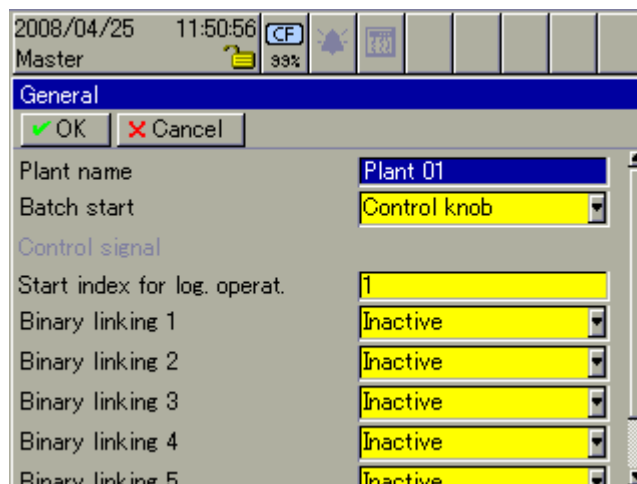

Plant name

The plant name (maximum length 15 characters) is displayed in the status and title bar for the display of a current or concluded batch report, and can be used as a batch text in the right-hand column of a batch report. It is also used in the *Alarm and event lists* menu.

⇒ Chapter 4.9 "Batches/Plants"

⇒ Chapter 6 "Alarm and Event Lists"

23 Configuration – Batches/Plants

Batch start This parameter defines how the batch report for a plant will be started and stopped.

| | |
|---------------|---|
| Inactive | Batch reporting cannot be started. |
| Control knob | Batch reporting can be started and stopped by the operator, using the control knob on the instrument. |
| Binary signal | Batch reporting is started and stopped by one of the binary signals. |
| Bar code | Batch reporting is started and stopped by a barcode reader. |

Control signal The control signal can only be activated if batch reporting is set to be started by a binary signal.



If the “Batch start” parameter is set to “Binary signal”, and the “Control signal” parameter is set to “inactive”, then batch reporting cannot be started. If “Control signal” is active, then a binary signal must be selected.

Start index ... This parameter is used as the start marker for binary linking. If binary linking is active for a batch text, then one of the 128 device-internal batch texts can be inserted into a current batch report immediately after the “Start at text” position.



Batch text used = Start at text + logic combination

**Binary linking
(logic operation)
1 – 6**

Depending on the settings, binary linking allows up to 64 different texts to be incorporated into the batch report under control of the binary signals.

Up to 128 batch texts are available, which can be defined in the setup program. The batch text that is used is defined by the “Start at text” parameter and “Logic operation”.

23 Configuration – Batches/Plants

23.3.2 Lines 1–10

Overview

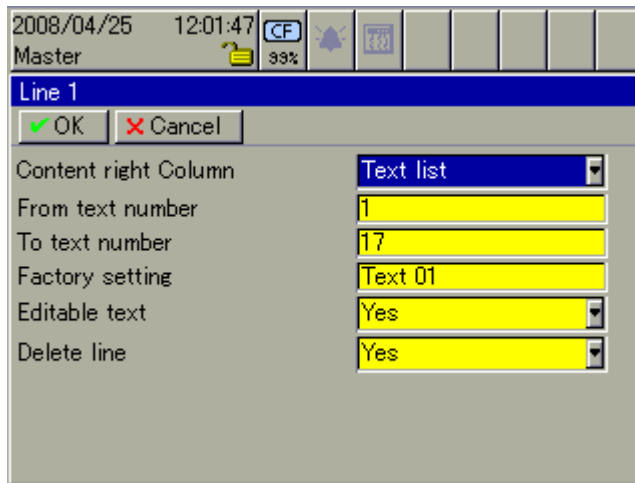

Right column contents

This determines how the text is formed in the right-hand column of a batch report.

| | |
|------------|--|
| Empty | The field remains empty. |
| Fixed text | A fixed text is used, defined by the factory default parameter. |
| Text list | One of 128 device-internal batch texts is used. After a reconfiguration, the factory default text will be shown at first. The user has to select the required text from the list in the “Current batch” visualization. The batch texts can be defined in the setup program. |

23 Configuration – Batches/Plants

| Bin. combined text | <p>One of 128 device-internal batch texts is used. The selection is made through up to 6 binary signals.</p> <p>Chapter 23.3.1 "General"</p> <p>If, for instance, 2 binary signals are active, then 4 texts can be inserted. If all 6 binary signals are active, then 64 different texts can be inserted. Binary linkage 1 has the value 2^0, binary linkage 2 has the value 2^1, and so on.</p> <table border="1" style="width: 100%; border-collapse: collapse; text-align: center;"> <thead> <tr> <th>B6</th> <th>B5</th> <th>B4</th> <th>B3</th> <th>B2</th> <th>B1</th> <th>yes</th> </tr> </thead> <tbody> <tr><td>0</td><td>0</td><td>0</td><td>0</td><td>0</td><td>0</td><td>0</td></tr> <tr><td>0</td><td>0</td><td>0</td><td>0</td><td>0</td><td>1</td><td>1</td></tr> <tr><td>0</td><td>0</td><td>0</td><td>0</td><td>1</td><td>0</td><td>2</td></tr> <tr><td>0</td><td>0</td><td>0</td><td>0</td><td>1</td><td>1</td><td>3</td></tr> <tr><td>.</td><td>.</td><td>.</td><td>.</td><td>.</td><td>.</td><td>.</td></tr> <tr><td>.</td><td>.</td><td>.</td><td>.</td><td>.</td><td>.</td><td>.</td></tr> <tr><td>.</td><td>.</td><td>.</td><td>.</td><td>.</td><td>.</td><td>.</td></tr> <tr><td>1</td><td>1</td><td>1</td><td>1</td><td>0</td><td>0</td><td>60</td></tr> <tr><td>1</td><td>1</td><td>1</td><td>1</td><td>0</td><td>1</td><td>61</td></tr> <tr><td>1</td><td>1</td><td>1</td><td>1</td><td>1</td><td>0</td><td>62</td></tr> <tr><td>1</td><td>1</td><td>1</td><td>1</td><td>1</td><td>1</td><td>63</td></tr> </tbody> </table> <p>0 = set to inactive, or no active signal 1 = not set to inactive, and signal is active</p> <p>The "Start at text" parameter is added to the text column for the output of the batch text.</p> | B6 | B5 | B4 | B3 | B2 | B1 | yes | 0 | 0 | 0 | 0 | 0 | 0 | 0 | 0 | 0 | 0 | 0 | 0 | 1 | 1 | 0 | 0 | 0 | 0 | 1 | 0 | 2 | 0 | 0 | 0 | 0 | 1 | 1 | 3 | . | . | . | . | . | . | . | . | . | . | . | . | . | . | . | . | . | . | . | . | . | 1 | 1 | 1 | 1 | 0 | 0 | 60 | 1 | 1 | 1 | 1 | 0 | 1 | 61 | 1 | 1 | 1 | 1 | 1 | 0 | 62 | 1 | 1 | 1 | 1 | 1 | 1 | 63 |
|-----------------------|--|----|----|----|----|-----|----|-----|---|---|---|---|---|---|---|---|---|---|---|---|---|---|---|---|---|---|---|---|---|---|---|---|---|---|---|---|---|---|---|---|---|---|---|---|---|---|---|---|---|---|---|---|---|---|---|---|---|---|---|---|---|---|---|----|---|---|---|---|---|---|----|---|---|---|---|---|---|----|---|---|---|---|---|---|----|
| B6 | B5 | B4 | B3 | B2 | B1 | yes | | | | | | | | | | | | | | | | | | | | | | | | | | | | | | | | | | | | | | | | | | | | | | | | | | | | | | | | | | | | | | | | | | | | | | | | | | | | | | | |
| 0 | 0 | 0 | 0 | 0 | 0 | 0 | | | | | | | | | | | | | | | | | | | | | | | | | | | | | | | | | | | | | | | | | | | | | | | | | | | | | | | | | | | | | | | | | | | | | | | | | | | | | | | |
| 0 | 0 | 0 | 0 | 0 | 1 | 1 | | | | | | | | | | | | | | | | | | | | | | | | | | | | | | | | | | | | | | | | | | | | | | | | | | | | | | | | | | | | | | | | | | | | | | | | | | | | | | | |
| 0 | 0 | 0 | 0 | 1 | 0 | 2 | | | | | | | | | | | | | | | | | | | | | | | | | | | | | | | | | | | | | | | | | | | | | | | | | | | | | | | | | | | | | | | | | | | | | | | | | | | | | | | |
| 0 | 0 | 0 | 0 | 1 | 1 | 3 | | | | | | | | | | | | | | | | | | | | | | | | | | | | | | | | | | | | | | | | | | | | | | | | | | | | | | | | | | | | | | | | | | | | | | | | | | | | | | | |
| . | . | . | . | . | . | . | | | | | | | | | | | | | | | | | | | | | | | | | | | | | | | | | | | | | | | | | | | | | | | | | | | | | | | | | | | | | | | | | | | | | | | | | | | | | | | |
| . | . | . | . | . | . | . | | | | | | | | | | | | | | | | | | | | | | | | | | | | | | | | | | | | | | | | | | | | | | | | | | | | | | | | | | | | | | | | | | | | | | | | | | | | | | | |
| . | . | . | . | . | . | . | | | | | | | | | | | | | | | | | | | | | | | | | | | | | | | | | | | | | | | | | | | | | | | | | | | | | | | | | | | | | | | | | | | | | | | | | | | | | | | |
| 1 | 1 | 1 | 1 | 0 | 0 | 60 | | | | | | | | | | | | | | | | | | | | | | | | | | | | | | | | | | | | | | | | | | | | | | | | | | | | | | | | | | | | | | | | | | | | | | | | | | | | | | | |
| 1 | 1 | 1 | 1 | 0 | 1 | 61 | | | | | | | | | | | | | | | | | | | | | | | | | | | | | | | | | | | | | | | | | | | | | | | | | | | | | | | | | | | | | | | | | | | | | | | | | | | | | | | |
| 1 | 1 | 1 | 1 | 1 | 0 | 62 | | | | | | | | | | | | | | | | | | | | | | | | | | | | | | | | | | | | | | | | | | | | | | | | | | | | | | | | | | | | | | | | | | | | | | | | | | | | | | | |
| 1 | 1 | 1 | 1 | 1 | 1 | 63 | | | | | | | | | | | | | | | | | | | | | | | | | | | | | | | | | | | | | | | | | | | | | | | | | | | | | | | | | | | | | | | | | | | | | | | | | | | | | | | |
| Plant name | <p>The plant name is shown.</p> <p>⇒ Chapter 23.3.1 "General"</p> | | | | | | | | | | | | | | | | | | | | | | | | | | | | | | | | | | | | | | | | | | | | | | | | | | | | | | | | | | | | | | | | | | | | | | | | | | | | | | | | | | | | |
| Batch No. plant 1 – 3 | <p>One of three batch numbers is used together with an additional text ("Fixed text"). The batch number is incremented by one at the end of a batch. It can be preset in the <i>Parameterization</i> menu.</p> | | | | | | | | | | | | | | | | | | | | | | | | | | | | | | | | | | | | | | | | | | | | | | | | | | | | | | | | | | | | | | | | | | | | | | | | | | | | | | | | | | | | |
| Batch start | Start (date and time) of a batch report. | | | | | | | | | | | | | | | | | | | | | | | | | | | | | | | | | | | | | | | | | | | | | | | | | | | | | | | | | | | | | | | | | | | | | | | | | | | | | | | | | | | | |
| Batch end | End (date and time) of a batch report. | | | | | | | | | | | | | | | | | | | | | | | | | | | | | | | | | | | | | | | | | | | | | | | | | | | | | | | | | | | | | | | | | | | | | | | | | | | | | | | | | | | | |
| Batch duration | The time difference between batch start and batch end. | | | | | | | | | | | | | | | | | | | | | | | | | | | | | | | | | | | | | | | | | | | | | | | | | | | | | | | | | | | | | | | | | | | | | | | | | | | | | | | | | | | | |

23 Configuration – Batches/Plants

| | |
|---------------------|---|
| Bar code | The text in the selected line will be loaded by a barcode reader. ⇒ Chapter 4.9.3 |
| External text 1 – 9 | The text in the selected line will be loaded with one out of a maximum of nine interface texts. |

From Text No. This parameter is available if the text in the right-hand column is created from the internal text list, and is the first text from the list that is available for selection by the user.

To Text No. This parameter is available if the text in the right-hand column is created from the internal text list, and is the last text from the list that is available for selection by the user.

Factory setting The factory setting (default text) is inserted into the current batch report if the text in the right-hand column is formed from “Fixed text”, “Text list” or “Bar code”. If the factory setting needs to be altered, then the data must be edited in the current batch report (). To do this, the “Edit text” parameter must be active.

Editable text This parameter makes it possible to alter a text within the current batch report.

| | |
|-----|---|
| No | The text can only be altered through the settings “Right column contents” and “Factory setting”. |
| Yes | The text can additionally be altered for the current batch report. Depending on parameter "Delete line", the configured text can be activated again automatically after the batch report is complete. |

Delete line This parameter determines whether or not an edited batch text (in the right column) will be reset after a batch is complete.

| | |
|-----|--|
| No | If a text has been edited in the right column or one of the interfaces has been changed, it will not be replaced by its original content at the end of the batch. It will remain as it is. |
| Yes | If a text in the right column has been changed by editing or by one of the interfaces, it will be replaced at the end of the batch by its original content (parameters "Content of right column" and "Factory setting"). |

23 Configuration – Batches/Plants

23.4 Final Remarks

The table below provides information again on the tools for configuring individual text fields.

| Text field | Setup program (file) | Text editor | Automatic | Setup program (online) and web server |
|---|----------------------|-------------|-----------|---------------------------------------|
| Texts in the left column | yes | yes | | |
| Fixed text, text list, log. combined text, plant name, barcode texts, ext. text yes | yes | yes | | yes |
| Batch No. | Additional text only | yes | yes | yes |
| Batch start, batchend, batch duration | | | yes | |
| Description of batches (recipe) | | | | yes |



Each one of the 10 lines is freely selectable and positionable.



Texts can be entered through barcode readers.

⇒ Chapter 4.9.3 "Batch Control with Barcode Reader"

⇒ Chapter 28.1 "Bar code"



If the factory setting has not been changed, texts can be added with a PC via the web server for the paperless recorder.

⇒ Chapter 27 "Web server"

23 Configuration – Batches/Plants

24 Configuration - Date and Time

24.1 Time Synch. ... Daylight Saving Time

Overview

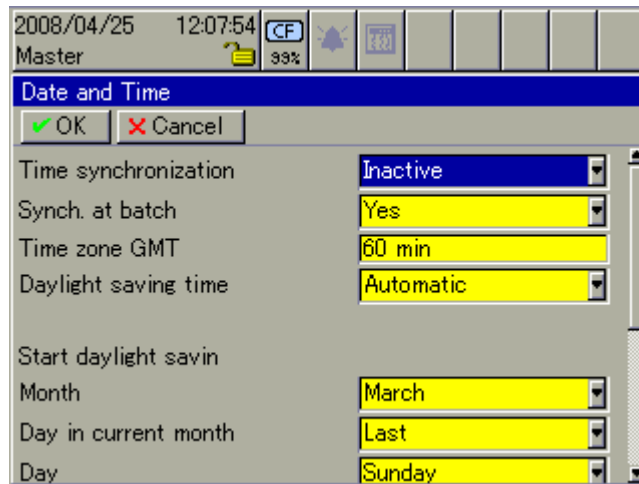

Time synch.

This parameter can be used to influence the time setting for the paperless recorder. When used in conjunction with a binary signal it can thus ensure that several recorders are synchronized to the same time.

| | |
|------------|---|
| Inactive | No synchronization takes place. |
| Binary I/O | <p>Select the signal that is to be used to activate the synchronization.</p> <p>The time is synchronized with the transition from Low to High (min. pulse duration = 125 ms).</p> <p>The seconds are decisive when changing the time. The time is advanced or retarded by a maximum of ± 30 seconds.</p> <p>Example: 12:55:29 -> 12:55:00 12:55:30 -> 12:56:00</p> |

Synch. at batch

This parameter determines whether the time synchronization can also be activated while batch reporting is in progress.

| | |
|-----|---|
| No | No synchronization will take place while a batch report is active. |
| Yes | Time synchronization will be carried out, even if a batch report is active. |

24 Configuration - Date and Time

Time zone (GMT)

The GMT parameter (Greenwich Mean Time) defines the time zone (ignoring any daylight saving time shift) in which the recorder is being operated. This setting is important for evaluating data with the PC Evaluation Software PCA3000.

| | |
|---------------------|---------------|
| Germany, France ... | 1 h = 60 min |
| England | 0 |
| Ukraine | 2 h = 120 min |
| Russia (Moscow) | 3 h = 180 min |

Daylight saving time

This parameter determines whether the daylight saving time change is active or inactive.

| | |
|-----------|--|
| Off | No daylight saving time change takes place. The parameters - described in Chapter 24.2 and Chapter 24.3 - will be blanked out, and cannot be configured. |
| Automatic | The daylight saving time change is active. The parameters - described in Chapter 24.2 and Chapter 24.3 - will determine the times of the changes. |

24 Configuration - Date and Time

24.2 Start Daylight Saving

When daylight saving time starts, the time is brought forwards by one hour.

Overview

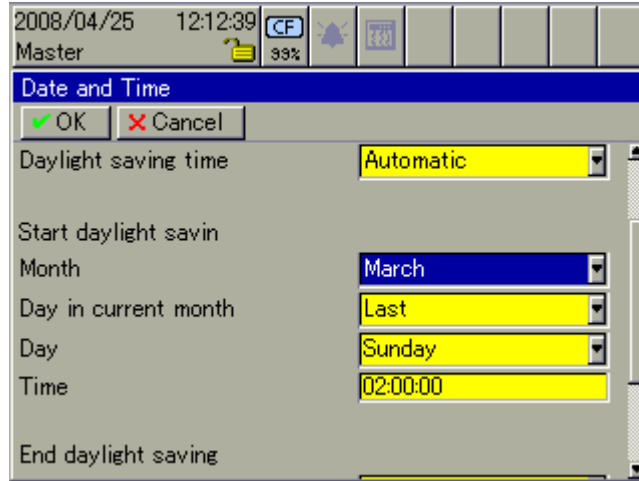

Month The month in which daylight saving time starts is selected here.

Day in current month This parameter is only available if a weekday has been configured in the “Day” parameter. In conjunction with “Day”, this sets which weekday in that month starts daylight saving time.

Example:

Month = March
Day of the month = last
Day = Sunday
Time = 02:00 AM

So the changeover to daylight saving time takes place at 02:00 on the last Sunday in March.

Day This parameter defines the day of the month on which daylight saving time starts.

| | |
|------------------------|--|
| Sunday ... Saturday | The weekday on which daylight saving starts. The “Day of the month” parameter also has an effect. |
| 1 ... 31 | The day (date) on which daylight saving time starts. |

Time The time at which daylight saving time starts is set here.



There is no validity check for the daylight saving time setting. Please check that the entry is correct.

24 Configuration - Date and Time

24.3 End Daylight Saving

When daylight saving time ends, the time is put back one hour.

Overview

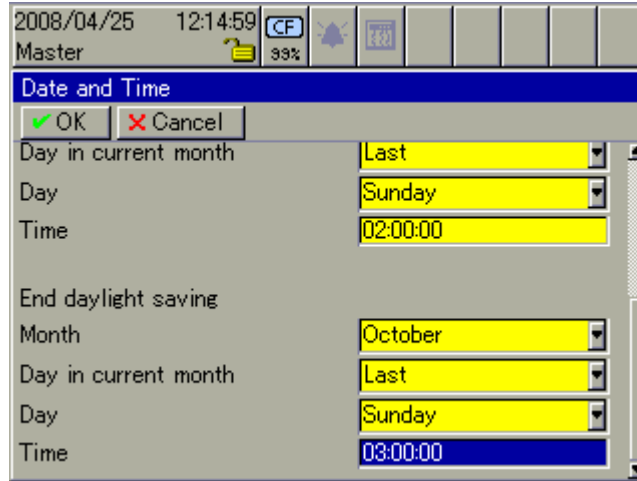

Month The month in which daylight saving time ends is selected here.

Day in current month This parameter is only available if a weekday has been configured in the “Day” parameter. In conjunction with “Day”, this sets which weekday in that month ends the daylight saving time.

Example:

Month = October
Day of the month = fourth
Day = Sunday
Time = 03:00 AM

So daylight saving time will end at 03:00 on the fourth Sunday in October.

Day This parameter defines the day of the month on which daylight saving time ends.

| | |
|-----------------|--|
| Monday – Sunday | The weekday on which daylight saving time ends. The “Day of the month” parameter also has an effect. |
| 1 ... 31 | The day (date) on which daylight saving time ends. |

Time The time at which daylight saving time ends is set here.



There is no validity check for the daylight saving time setting. Please check that the entry is correct.

25 Configuration - Undocumented Parameters

Overview

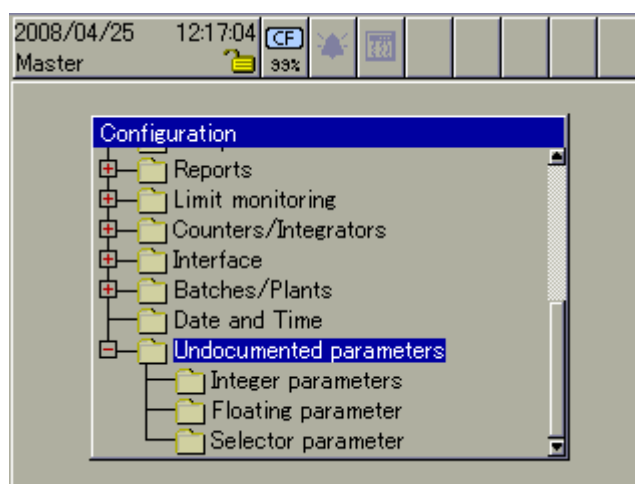

Undocumented parameters are used for extending the functionality of the paperless recorder. They should only be altered on express instruction from the manufacturer.

25 Configuration - Undocumented Parameters

26 Entering text and values

26.1 Text entry

26.1.1 Entering characters

If a Text entry field is selected, and then activated by pressing the control knob, then a text can be entered or altered.



The cursor (position marker) is at the end of the current setting. The active key or function that will be performed when the control knob is pressed is shown in blue.

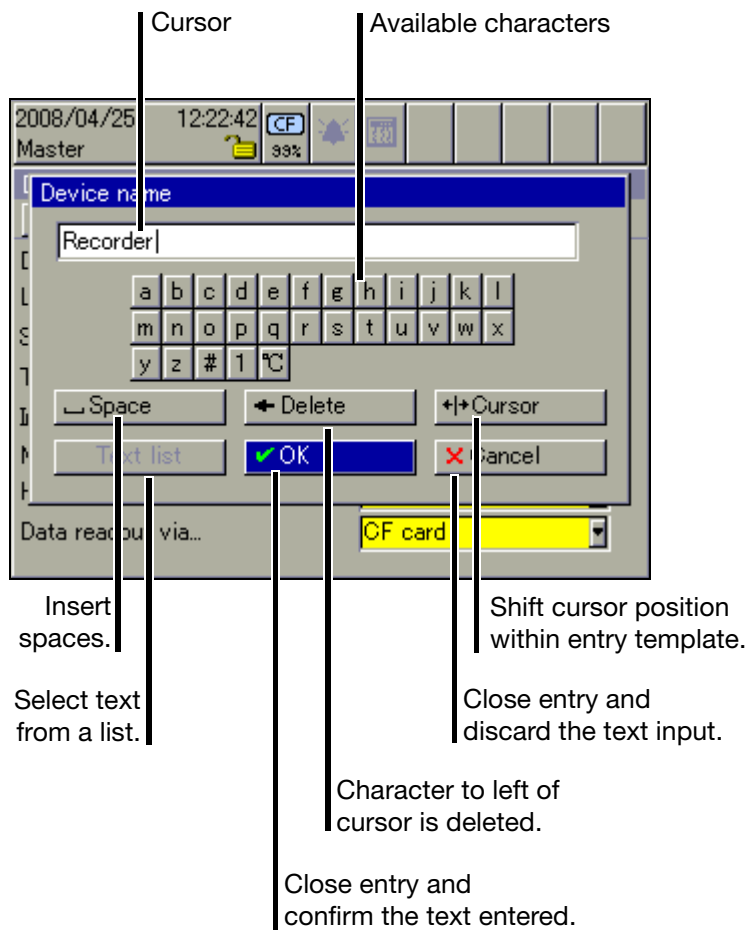

Available characters



The characters that are shown as available are just an example. They can be adjusted to suit your needs through the setup program.

26 Entering text and values

Character entry

- * Move the cursor onto the required character, and press the control knob. Another selection window will open.

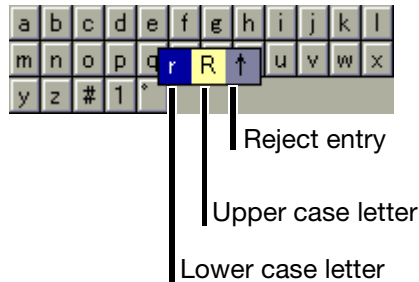

- * Rotate the control knob to select upper case (capital) or lower case (small) letters, or reject an entry, and activate/confirm the choice by pressing the control knob.

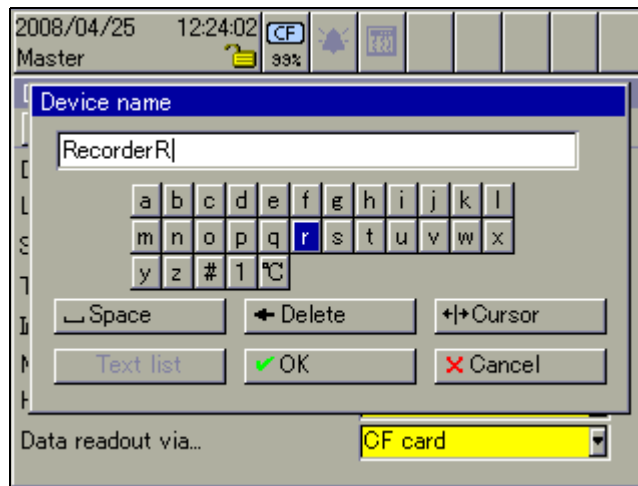

Entering special characters

Special characters are entered as text.

- * Select the # symbol and press the control knob.

All the special characters that can be selected will now be shown.

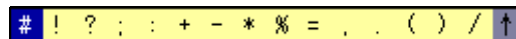

Here too the selection and confirmation of the characters are made by rotating and pressing the control knob.

Number entry

- * Select number "1", and press the control knob.

All the numbers that can be selected will now be shown.

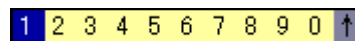

The selection and confirmation of the numbers are made by rotating and pressing the control knob.

26 Entering text and values

Select temperature unit

- * Select “ ” and press the control knob.

All the temperature units that can be selected will now be shown. For better legibility, the degree sign (°) and the unit of measure (C or F) are separated, and must be individually selected.

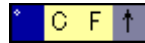

The selection and confirmation of the symbol is made by rotating and pressing the control knob.

26.1.2 Insert spaces

- * Select the space button () and press the control knob.

The space character will be inserted to the right of the cursor.

26.1.3 Delete character

- * Select the delete button () and press the control knob.

The character to the left of the cursor will be deleted.

26.1.4 Move cursor

- * Select the cursor positioning button () and press the control knob.

The cursor can now be moved. To end shifting, press the control knob again.

26.1.5 Enter text from text list

The last 20 texts that were entered (confirmed by OK) will be stored in the recorder, in an internal text list. This function can be used to call up the list and select a text for current application.

- * Call text list ().

The selection and confirmation of the required text are made by rotating and pressing the control knob.

26.1.6 Finish entry

- * Select the “OK” button () and press the control knob.

Character entry will now be ended. The text that was entered is accepted, and the dialog window is closed.

26 Entering text and values

26.1.7 Reject entry

- * Select the “Cancel” button () and press the control knob.

Character entry will now be ended. The text that was entered is **not** accepted, and the dialog window is closed. The previously active setting is retained.

26.2 Entry via selection field

If a selection field is selected, and then activated by pressing the control knob, then the text (value) can be entered from a previously defined list.



The cursor (position marker) is on the current setting.

- * Make the selection by rotating and pressing the control knob.

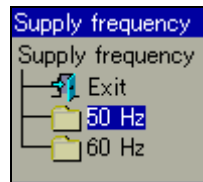

26.3 Entering values

26.3.1 Whole numbers (integers)

There are two possibilities for entering integer numbers:

- selection by altering the individual digits of a number, or
- selection by incrementing and decrementing.

Digit-by-digit entry of an integer

For this entry, each digit of the number (units, tens, ...) and the sign are selected with the control knob.

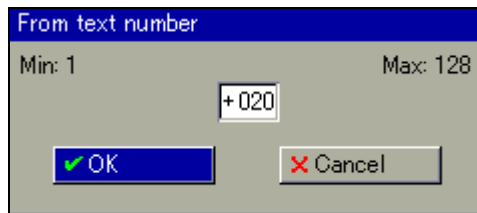

Example

- * Select "2" (the tens digit) by rotating the control knob ().
- * Press the control knob.

The tens digit is now shown in red, to indicate that this digit can now be altered (.

- * Rotate the control knob to alter the tens digits, and then confirm the entry by pressing the control knob.

The tens digit has now been altered, and is shown in blue again (.

Selection by incrementing and decrementing

For this entry, the complete number is reduced by 1 (decremented) or increased by 1 (incremented) with the control knob.

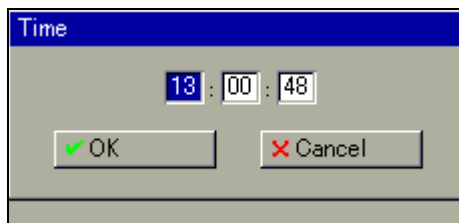

Example

- * Select the hour by rotating the control knob (.
- * Press the control knob.

The number is now shown in red, to indicate that it can now be altered (.

- * Rotate the control knob to alter the number, and then confirm the entry by pressing the control knob.

The number has now been altered, and is shown in blue again (.

26 Entering text and values

26.3.2 Real numbers (floating point)

To enter real numbers (with a decimal point), each digit of the number (units, tens, etc.), the decimal point position, and the sign are selected with the control knob.

Sequence

- Position the cursor.
- Enter the number or define the decimal point position.

For number entry, the number is inserted at the right of the cursor.

Cursor positioning

- * Select "Cursor" and press the control knob.

The real number is indicated by a blue background.

- * Rotate the control knob to move the cursor to the required position, and then press the control knob.



When a number is entered, it is inserted at the right of the cursor.
When deleting, the digit to the left of the cursor is deleted.

Character deletion

- * Position the cursor.
- * Select "Delete" and press the control knob.

The character to the left of the cursor will be deleted.

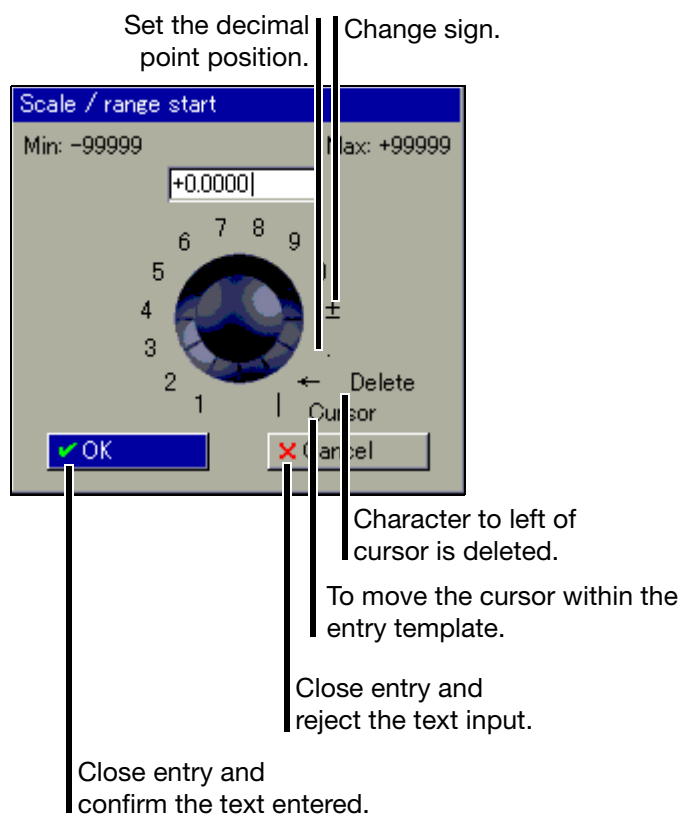

27.1 General

The web server is integrated in the paperless recorder as a standard feature. Four different modes of presentation are available:

- „Online Visualization (All Visualizations Except Batches)“
- „Three freely programmable HTML pages“
- „Online Visualization of Current Batch Reports“
- „4-Way View“

The web server can be accessed on the PC side with Microsoft® Internet Explorer by entering the IP address (e. g. <http://10.10.90.45>). DNS names can be assigned on the device. Therefore a device can also be accessed using the DNS names. For visualizing graphics, an SVG Viewer (from Adobe®, for instance) must be installed on the PC in addition to Internet Explorer.



Up to 4 PCs (clients) can have access to the device via the Ethernet interface.

Log-in

A password query has been activated in the factory. The user can switch it to inactive with the PC setup program.

Connect to 10.10.1.117

Realm

User name: Master

Password: ●●●●●

Remember my password

OK Cancel

If the option is active () the entry template will automatically be filled in the next time the web browser is restarted. The user only needs to confirm with OK.

Factory setting:
User = Master
Password = 9200



When entering the user name and password, distinctions of upper- and lower-case letters must be observed.

27 Web server

Home page

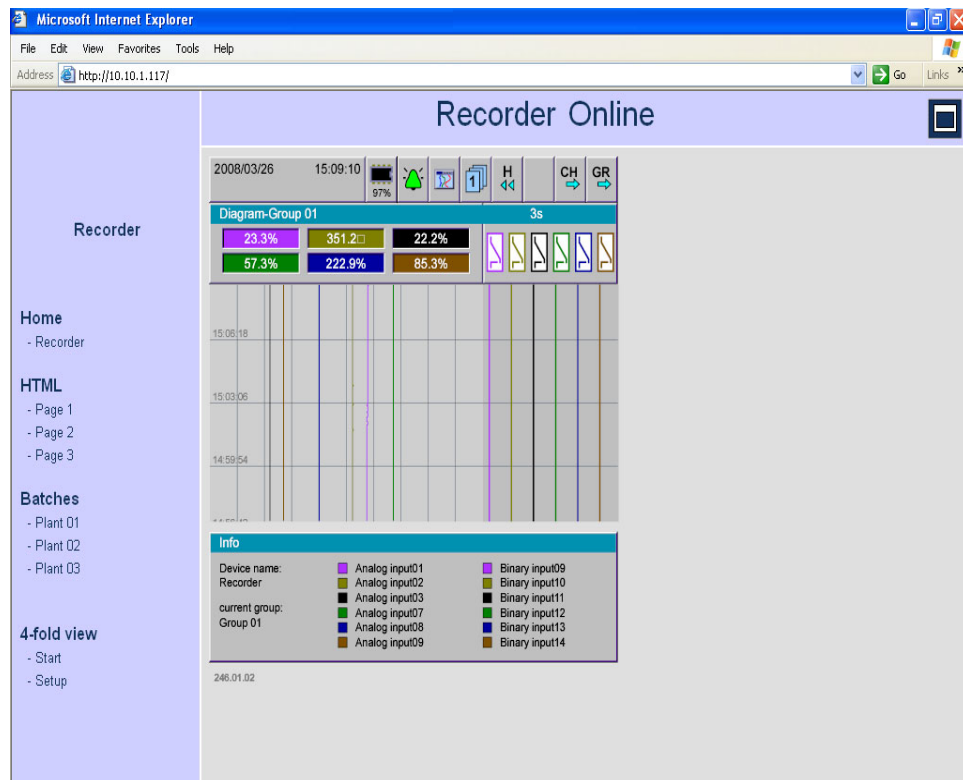

Online visualization automatically comes up as the home page if the web server is started by the browser or, if it has already been activated, the user (left) clicks the "Recorder" link.

Areas

The web server's display is divided into three areas:

- Header
- Navigation
- Visualization area

Header

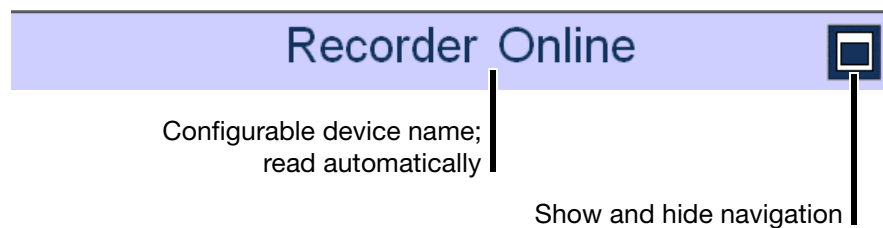

Navigation

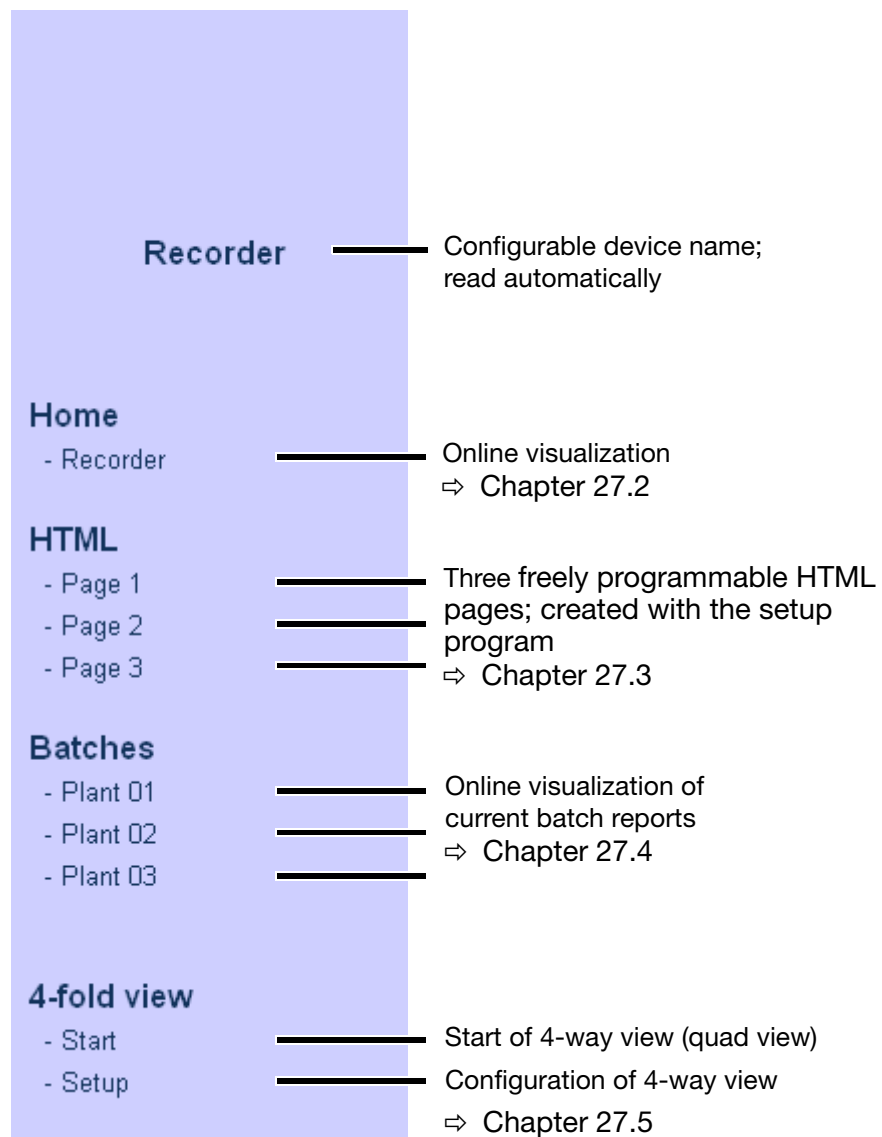

Individual pages can be brought up by clicking (left mouse button).

Visualization area

The visualization area shows current data for the paperless recorder. The most recent data are read from the device automatically every 3 seconds.

27 Web server

27.2 Online Visualization (All Visualizations Except Batches)

Data that are displayed correspond to the configured groups of the recorder.

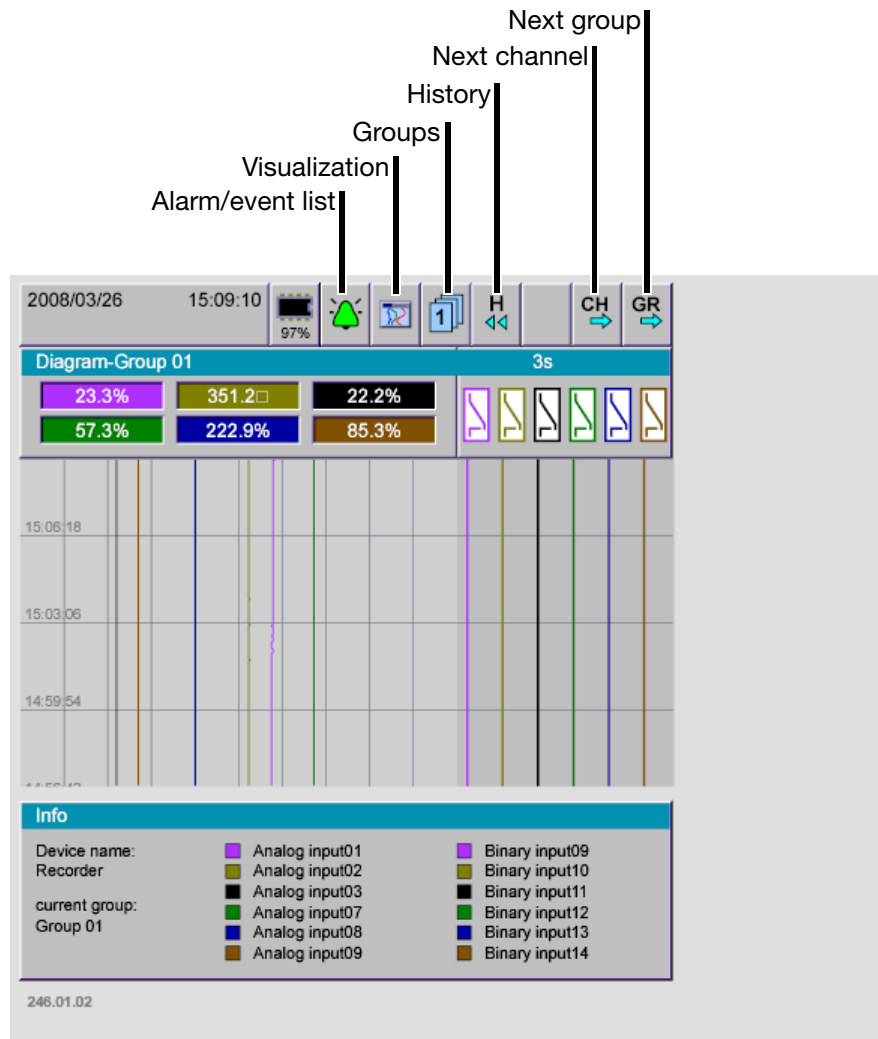

The sample screen shows the web server's home page. This page can be used to represent channels in the same manner as on the recorder's screen. (Left) click to bring up the available menus of the recorder.

Example

Switching to bar graph presentation

- * (Left) click the Visualization menu.

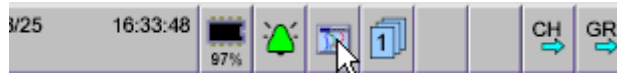

- * (Left) click the bar graph.

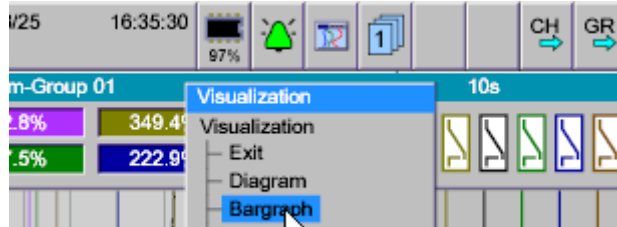

Result: The bar graph visualization type is activated.

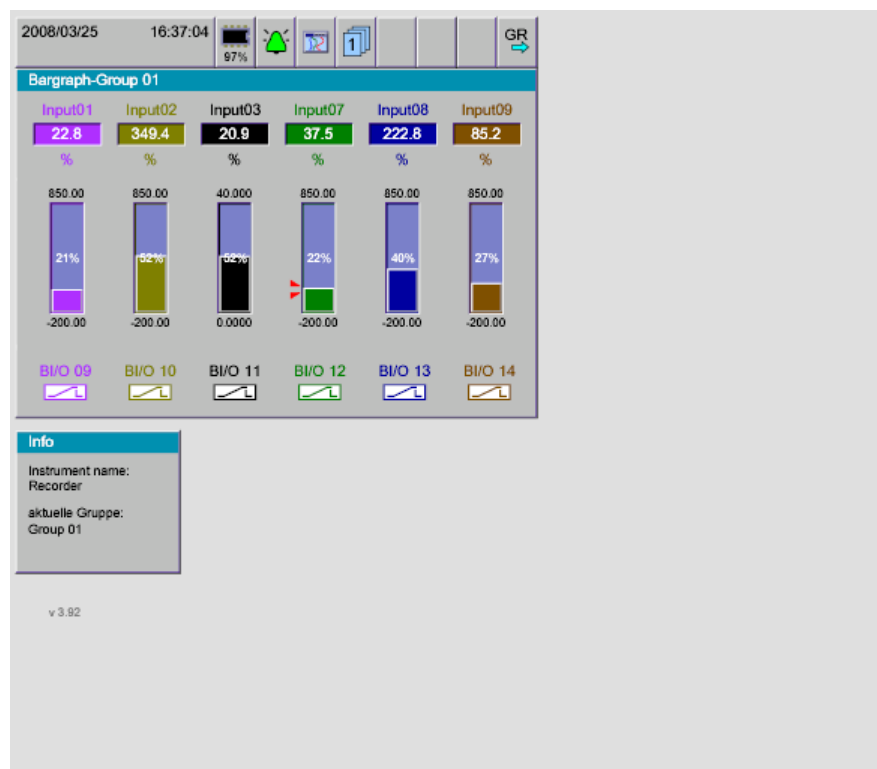

27 Web server

27.3 Three freely programmable HTML pages

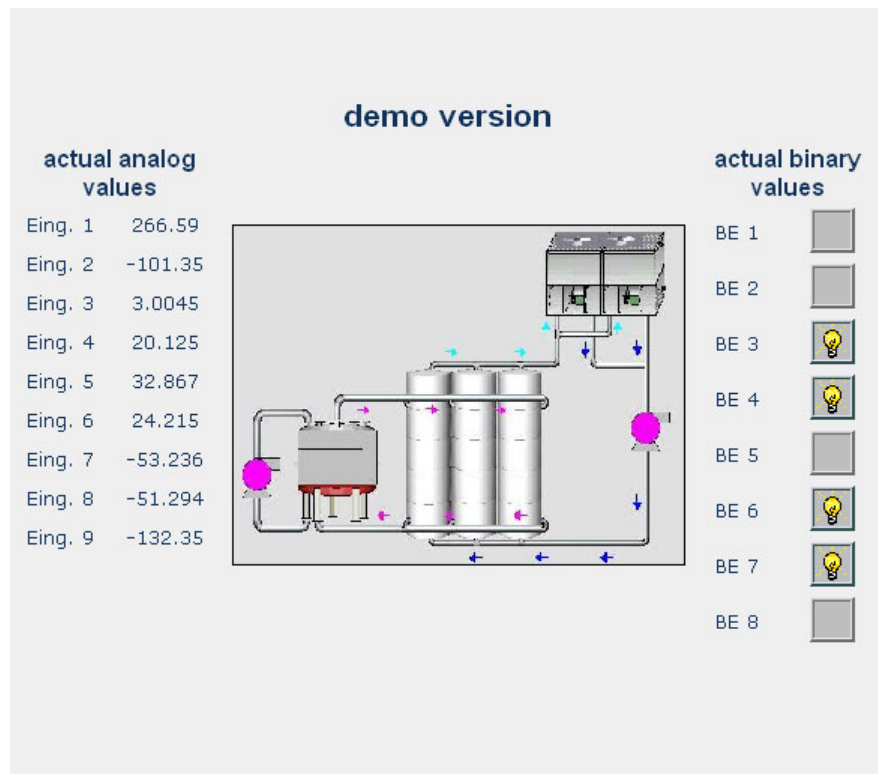

The sample screen shows one of three freely programmable HTML pages. These pages can be created and modified with the setup program.



Further information can be obtained from the instructions on the setup program (59492).

27.4 Online Visualization of Current Batch Reports

When batch pages of a plant are called up, the current data from the recorder is read and displayed.

Batch recording is active  or inactive

Editable text field; (left) click and enter text

Batch 01

Batch 01 active: 

| | |
|----------------|--|
| Program name | Default Text 01 |
| Customer info | Default Text 03 |
| Batch name | Default Text 05 |
| Batch number | 900000006Default Text |
| Batch start | 2008/03/25 16:12:56 |
| Batch end | 2008/03/25 16:13:05 |
| Batch duration | 00:09 |
| Remarks | <div style="border: 1px solid gray; height: 80px; width: 100%;"></div> |

Restore original texts 

Send texts to the recorder 

The "Appendix" can be viewed in visualization "Completed batch" using function "Batch evaluation"



The plant pages (batch pages) only match the pages in the recorder if the factory setting of the instrument has been retained. If plant data have been changed in the recorder, HTML pages must be updated to reflect the changes.

27 Web server

27.5 4-Way View

Visualization for up to four devices is possible with 4-way view. The visualizations may involve one device or up to four different ones. Different visualizations can be activated for each display (for example two views of a device, curve presentation and bar graph display).

Before 4-way view can be used, the function must be configured.

* (Left) click "Setup".



Setup

The setup window appears, where all IP addresses in use can be configured.

Configuration of Quad View isn't done. Please fill out adresse fields and save config.

Quad View - Setup

| Quad View | |
|----------------------------------|----------------------------------|
| Adress 1 <input type="text"/> | Adress 3 <input type="text"/> |
| Adress 2 <input type="text"/> | Adress 4 <input type="text"/> |

If all or some fields are empty, they have not been configured for 4-way view yet.

* Complete the configuration and click "Save config".

Result: IP addresses (or DNS names) that have been entered are saved as cookies in the PC and remain intact until cookies are deleted (forexample by the PC browser).

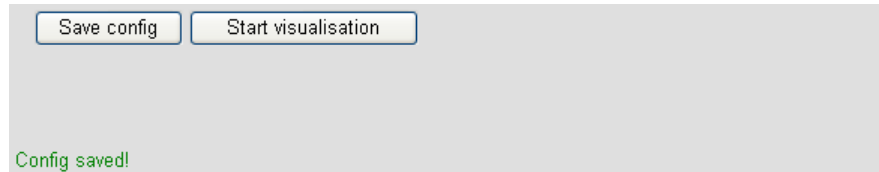

* Click "Start" or "Start visualization".

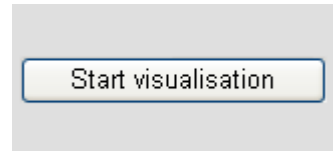

Result: 4-way view starts.

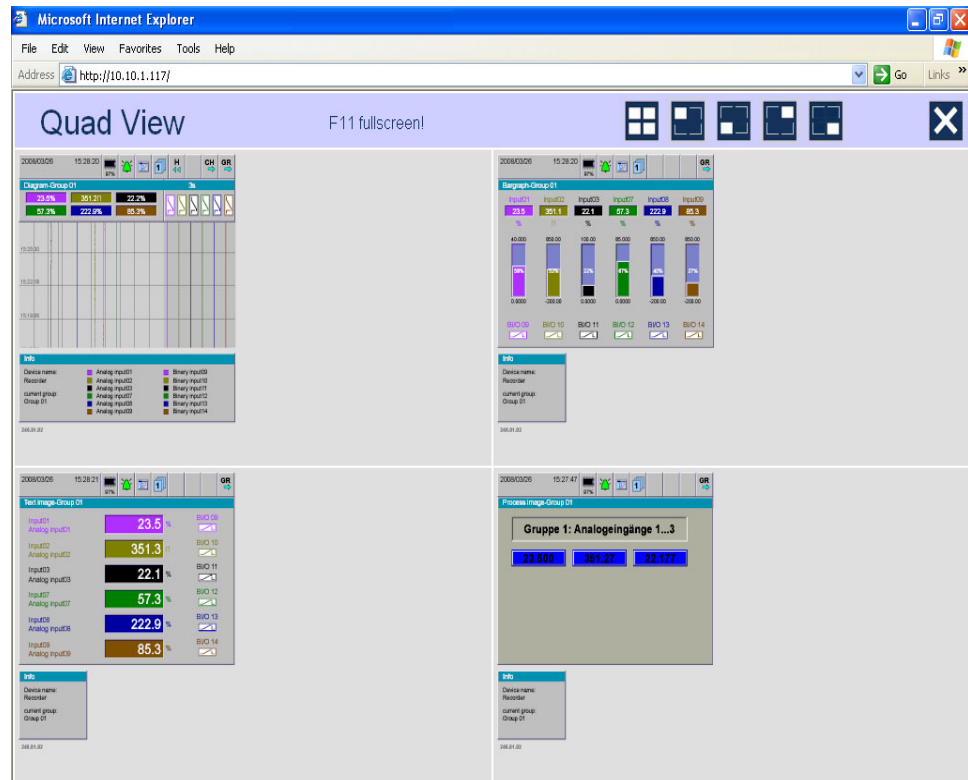

In the example shown here, two different recorders are accessed (recorder 1 top left and top right, recorder 2 bottom left and bottom right). Two different visualizations are shown for each recorder.

Switching between the four visualizations works as shown in Chapter 27.2 "Online Visualization (All Visualizations Except Batches)".

27 Web server

Unlike a normal online visualization, the header contains modified buttons.

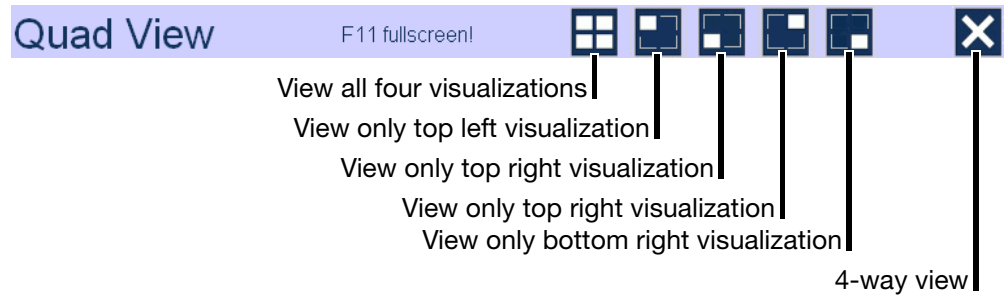

28.1 Bar code

28.1.1 Batch control

Plant 1



Plant 2



Plant 3



Start



Stop



Reset
entry



28 Appendix

28.1.2 Batch texts

Product name SUPER PRODUCT



SUPER PRODUCT

NORMAL PRODUCT



NORMAL PRODUCT

TOOTHED DISK 34



TOOTHED DISK 34

AXIS ROD 45



AXIS ROD 45

Product numbers 645736



645736

012876



012876

345435



345435

Job numbers

A83737



A83737

A4555455



A4555455

A455445



A455445

**Personnel
number**

4576



4576

7665



7665

Numerics

1-channel presentation 57
4-way view 192

A

Active operating mode 35
Alarm and event lists 44, 73
Alarm delay 144
Alarm limits 56–57
Alarm lists 73
Alarms, analog inputs 32
Alarms, counters/integr. 32
Alarms, ext. Analog inputs 32
Alarms, ext. binary input 31
Analog input 20
Analog inputs 105
 External 20–21, 117
Arrangement of the documentation 10
Audit trail 89

B

Backup -> CF card 79
Bar code 63, 158, 161, 170, 195
Bar graph presentation 53–54, 56
Barcode reader 155
Batch 31, 53–54, 60, 95, 163
 analyze 62
 automatic start 61
 change 60, 62
 edit 60
Batch numbers 95
Batch reports 163
Batch start/stop 61
Batch status 61
Batch texts 164
Batches 50, 67, 73, 125
 Start manually 60
Binary 53
Binary I/O 31
Binary I/O alarm 31
Binary input/output 130
Binary inputs
 External 121
Binary inputs/outputs 111
Binary Presentation 58
Binary presentation 54
Binary signals 31, 39, 132
 Overview 31

Binary traces 132

C

CF card -> config. data 79
CF card -> user list 79
Change password 82
Channel description 57
Channel name 57
Channel step-on 44, 55, 59, 69
Cold junction 105
Color display 17, 19
Combination alarm 32
Comment Entry 67
Comment entry 53–54
Commissioning 9
CompactFlash 11, 17–18
CompactFlash memory card (external) 37
Completed batches 62
Config data -> CF card 79
Configuration 90, 97
Control knob 17, 19, 43
Counter 23–24, 66, 130, 145
 presetting 26, 94
 reset 26, 94
Counters/integrators 53–54, 66
Counting frequency (counter/integrator) 23–24
Counting frequency (counters/integrators) 24
Cursor 69
Curve presentation 53–55
Customized linearization 105

D

Data
 Readout via interface 40
Data lost 99
Data readout
 via interface 77
 with a CF memory card 77
Data readout via ... 100
Data recording 37
Data security 38
Date 94, 173
Daylight saving time 173
Device data 99
Device Information 84
Device Manager 81
Device manager 44
Device name 99
DHCP 156

Diagram header *44, 58, 132*
Diagram speed *34*
Diagram view *46, 131*
Digital presentation *103*
Display *17, 19*
Display off *18*
Displays and controls *17*
DNS *157, 185*

E

Eco mode *35, 133–136*
Edit batch *61*
Electrostatic discharge (ESD) *9*
Entering values *183*
Envelope *132*
Eth. info *88*
Ethernet *155–157*
Event lists *73*
Event Mode *135*
Event mode *34, 55*
Ext. binary input *31*
Ext. texts *87*
External analog input *20*
External analog inputs *20–21, 117*
External binary inputs *121*

F

Factory setting *91*
Fine calibration *94*
Firmware *79*
Flow rate *23–24*

G

Gateway *157*
Group *67, 163*
Group alarms *32*
Group presentation *57*
Group selection *44, 55, 59*
Group step-on *44, 55, 59*
Groups *50, 125*

H

Hardware *85*
Header *18, 43*
High-speed counters *23–24, 145, 147*
 reset *26*

29 Index

History 44, 69
History memory 100
Hysteresis (differential) 128, 142

I

Info 85
Installation Instructions 15, 21–22
Instrument documentation in printed form 10
Instrument documentation in the form of PDF files 10
Integrator 23
Integrator with Out of Range 99
Integrators 23, 66, 130, 145
 presetting 26, 94
 reset 26, 94
Interfaces 155
Internal analog inputs 20–21
Internal memory 37
Introduction 9
IP address 157, 185

K

Keys 13

L

Language 99
Life-cycle data management 40
Limit alarms 31
Limit monitoring 141
Limit value 152
Limits 31
Logic combination 169
Logic module 28–29
Log-in 82
Log-in and Log-out 82
Log-out 82

M

Main memory (RAM) 37
Math 28
Math module 28
Max. value 59
Measurement range exceeded 106, 110, 117, 120
Measurement selection 132
Memory alarm 39, 99
Memory alarms 99
Memory manager 44

- Memory managers 77
- Memory presentation 44, 55, 69
- MIN/MAX value recording 132
- MIN/MAX values 132
- Modbus 157, 159
 - Master 159
- Module 86

N

- Nameplate 20, 22
- Network 156
- Normal display 48
- Normal mode 55, 133
- Normal operation 34
- Note signs 12
- Numerical measurement display 18, 44, 46, 55, 69

O

- Operating mode 55
- Operating modes 34
- Operating time counter 24, 145
 - reset 26
- Operator level 44, 48, 53
- Out-of-range 140
- Over value 110, 117, 120
- Overrange 106, 110, 117, 120

P

- Parameterization 90, 93
- Password 82, 185
- Password management 79
- PCA3000 11, 39
- PCC 11, 40
- Plant 60, 125, 163
- Plants 50, 95
- Power LED 17, 19
- Presentation modes 13
- Probe break 142
- Process image presentation 53–54, 58, 102
- PROFIBUS-DP 20–21

R

- Recording period (counter/integrator) 25
- Relay 22, 115
- Relays 31
- Report 53–54, 59, 103, 137

Report step-on 59
Reset (counter/integrator) 26
Returning 9
Rights 82, 97
RS232 161
RS232 / RS485 155, 158
RS232 for barcode reader 161

S

Sampling rate 55
Save all + update CF card 79
Screen 101
Screen saver 18
Screen switch-off 101
Screen texts 13
Scroll 69
Search 69
Serial interface 20–21
Service 91
Setup program 97
Stainless steel 16
stainless steel 15
Status bar 18, 45
Status LED 17, 19
Storage cycle (memory rate) 34, 38, 134
Storage status 133
Stored value 34, 38, 133
Supply frequency 99
SVG 185
Symbols 47, 76
Synchronization Time 140, 145

T

Temperature unit 99
Text entry 179
Text picture presentation 53–54
Textual presentation 57
Time 94, 173
Time period 59
Timed mode 34, 55, 136
Title bar 18, 45
Tolerance 127, 134
Tolerance band comparison 129
Tolerance infringement 128
Touchpad 16, 19, 43
Type coding 20, 22
Typographical Conventions 12

U

Under value *106, 110, 117, 120*
Underrange *106, 110, 117, 120*
Undocumented parameters *177*
Update CF card *79*
USB *18, 39–40, 77–79*
User *185*
User list *79*
Users *81–82, 93*
 logged in *81, 93*
 logged out *81, 93*
 Standard (default) password *82*
 Standard (default) user *82*

V

Value below measurement range *106, 110, 117, 120*
Version *84*
Visualization *44, 53*
Visualization window *18, 47*

W

Warning signs *12*
Warranty *9*
Web server *185*
Weighting (counter/integrator) *23–24*
Writing configuration data to CF card / reading from CF card *79*

Z

Zoom *69*

2009-08-07/00578758

WEST
Control Solutions

Austria T: +43 (0) 2236 691 121
China T: +86 22 8398 8098
France T: +33 (1) 77 80 90 40
Germany T: +49 (0) 561 505 1307
UK T: +44 (0) 1273 606 271
USA T: +1 800 866 6659

Email Inquiries@West-CS.com
Website www.West-CS.com



WEST  **Partlow**
