



- 3 or 6 Analog Inputs
- 5.5" TFT Display
- 4 logic inputs, 3 relay outputs
- Set-up, Comms and Evaluation software
- 144 x 144 mm
- Maths and web server options
- RS232/485 or Ethernet communications

Description

The DataVU 5 features a high quality 5-inch color display, in which the measurement data can be displayed in a vertical direction, similar to ordinary chart recorders. Measurement data are stored electronically, and are available for evaluation on screen as well as in the PC. The integrated data management features ensures fast traceability of process data referred to specific installations.

The DataVU 5 can be fitted with 3 or 6 electrically isolated measurement inputs, as required. The recorder can be programmed from eight front panel keys, or by using a PC via a CompactFlash card or one of the communication interfaces.

The bezel size is 144 mm x 144 mm, depth behind panel 214 mm.

3/6 analog inputs

Thermocouple
RTD
Voltage
Current

(inputs are electrically isolated)

Power supply

110 -240V AC
or
20 – 53V AC/DC

Features

5" TFT Color screen
320 x 240 pixels,

Compact Flash card
≤2GB for transfer of measurements and configuration

CPU card
With main memory and measurement data memory (FLASH memory) for approx. 350,000 measurements



Extra codes

4 Binary inputs
the state of each can be graphically displayed

3 relays
Changeover (SPDT) 3A, 230V

RS232/RS485 or Ethernet interface
for process and configuration data

Math and logic module

Counters and integrators

Software (accessory)

Set-up program
For configuration

Evaluation software
for representation and evaluation of measurement data

Communication software
for automatic data readout (also via modem)

Key Features

- Measurement data presented numerically as vertical charts (with scaling), numerical display, or as a bar graph
- Presentation of event traces such as "Binary inputs"
- On-site availability of measurements in the FLASH memory
- Measurement data retained even after a power interruption
- Saving of data sets on CompactFlash card
- Instrument configuration through the front panel keys or the configuration software (CompactFlash card or interface)
- Interrogation of archived data with PC evaluation program
- Search function for analysis of historic data
- Adapt memory storage cycles to the specific process, using normal, time-of-day and event operation
- Freely configurable inputs
- Internal sampling rate 250 msec for 3 or 6 analog inputs, minimum storage cycle 1 sec
- Counters and integrators (6 channels)
- Math and logic module (6 channels)
- Integrated web server

Technical Data

Analog Inputs

Input for DC voltage, DC current

Basic range	Accuracy	Input resistance
-20 to +70 mV -3 to +105 mV -10 to +210 mV -0.5 to +12 V -0.05 to +1.2 V -1.2 to +1.2 V -10 to +12 V	±80 µV ±100 µV ±240 µV ±6 mV ±1 mV ±2 mV ±12 mV	$R_{IN} \geq 1 \text{ M}\Omega$ $R_{IN} \geq 1 \text{ M}\Omega$ $R_{IN} \geq 1 \text{ M}\Omega$ $R_{IN} \geq 470 \text{ k}\Omega$ $R_{IN} \geq 470 \text{ k}\Omega$ $R_{IN} \geq 470 \text{ k}\Omega$ $R_{IN} \geq 470 \text{ k}\Omega$
Minimum span	5 mV	
Range start/end	freely programmable within the limits in 0.01 mV steps	
-2 to +22 mA -22 to +22 mA	±20 µA ±44 µA	burden voltage ≤ 1 V burden voltage ≤ 1 V
Minimum span	0.5 mA	
Range start/end	freely programmable within the limits in 0.01 mA steps	
Overrange / underrange	according to NAMUR NE 43. Measurement valid from 3.8 mA to 20.5 mA. Fault indicated by <=3.6 mA or >=21.0 mA	
Sampling cycle	3 or 6 channels 250 msec	
Input filter	2nd order digital filter; filter constant adjustable from 0 to 10.0 sec	
Test voltage for electrical isolation	350 V (via optocoupler)	
Resolution	> 14 bit	

Thermocouple

Designation	Type	Standard	Meas. range	Accuracy ¹
Fe-Con	L	DIN 43 710	-200 to +900 °C	±0.1 %
Fe-Con	J	EN 60 584	-210 to +1200 °C	±0.1% from -100 °C
Cu-Con	U	DIN 43 710	-200 to +600 °C	±0.1 % from -150 °C
Cu-Con	T	EN 60 584	-270 to +400 °C	±0.15 % from -150 °C
NiCr-Ni	K	EN 60 584	-270 to +1372 °C	±0.1 % from -80 °C
NiCr-Con	E	EN 60 584	-270 to +1000 °C	±0.1 % from -80 °C
NiCrSi-NiSi	N	EN 60 584	-270 to +1300 °C	±0.1 % from -80 °C
Pt10Rh-Pt	S	EN 60 584	-50 to +1768 °C	±0.1 5% from 0 °C
Pt13Rh-Pt	R	EN 60 584	-50 to +1768 °C	±0.15% from 0 °C
Pt30Rh-Pt6Rh	B	EN 60 584	0 to 1820 °C	±0.1 5% from 400 °C
W3Re/W25Re	D		0 to 2400 °C	±0.1 5% from 500 °C
W5Re/W26Re	C		0 to 2320 °C	±0.1 5% from 500 °C
Chromel-Copel		GOST R 8.585-2001	-200 to +800 °C	±0.1 %
Minimum span	Type L, J, U, T, K, E, N, chromel-copel: Type S, R, B, D, C:		100 °C 500 °C	
Range start/end	freely programmable within the limits, in 0.1 °C steps			
Cold junction	Pt100 internal or thermostat external constant			
Cold junction accuracy (internal)	± 1 °C			
Cold junction temperature (external)	-50 to +150 °C, adjustable			
Sampling cycle	3 or 6 channels, 250 msec			
Input filter	2nd order digital filter; filter constant adjustable from 0 to 10.0 sec			
Test voltage for electrical isolation	350 V (via optocoupler)			
Resolution	> 14 bit			
Special features	also programmable in °F			

¹ The accuracy refers to the maximum measuring range. The accuracy is reduced with short spans.

RTD

Designation	Standard	Connection circuit	Meas. range	Accuracy	Measuring current
Pt100	EN 60 751 (TC = $3.85 \cdot 10^{-3} 1/^{\circ}\text{C}$)	2/3-wire 2/3-wire 4-wire 4-wire	-200 to +100 °C -200 to +850 °C -200 to +100 °C -200 to +850 °C	± 0.5 °C ± 0.8 °C ± 0.5 °C ± 0.5 °C	500 μA 250 μA 500 μA 250 μA
Pt100	JIS 1604 (TC = $3.917 \cdot 10^{-3} 1/^{\circ}\text{C}$)	2/3-wire 2/3-wire 4-wire 4-wire	-200 to +100 °C -200 to +650 °C -200 to +100 °C -200 to +650 °C	$\pm 0,5$ °C ± 0.8 °C ± 0.5 °C ± 0.5 °C	500 μA 250 μA 500 μA 250 μA
Pt100	GOST 6651-94 A.1 (TC = $3.91 \cdot 10^{-3} 1/^{\circ}\text{C}$)	2/3-wire 2/3-wire 4-wire 4-wire	-200 to +100 °C -200 to +850 °C -200 to +100 °C -200 to +850 °C	± 0.5 °C ± 0.8 °C ± 0.5 °C ± 0.5 °C	500 μA 250 μA 500 μA 250 μA
Pt500	EN 60 751 (TC = $3.85 \cdot 10^{-3} 1/^{\circ}\text{C}$)	2/3-wire 2/3-wire 4-wire 4-wire	-200 to +100 °C -200 to +850 °C -200 to +100 °C -200 to +850 °C	± 0.5 °C ± 0.8 °C ± 0.5 °C ± 0.5 °C	250 μA 250 μA 250 μA 250 μA
Pt1000	EN 60 751 (TC = $3.85 \cdot 10^{-3} 1/^{\circ}\text{C}$)	2/3-wire 2/3-wire 4-wire 4-wire	-200 to +100 °C -200 to +850 °C -200 to +100 °C -200 to +850 °C	± 0.5 °C ± 0.8 °C ± 0.5 °C ± 0.5 °C	500 μA 250 μA 500 μA 250 μA
Ni100	DIN 43 760 (TC = $6.18 \cdot 10^{-3} 1/^{\circ}\text{C}$)	2/3-wire 4-wire	-60 to +180 °C -60 to +180 °C	± 0.4 °C ± 0.4 °C	500 μA 500 μA
Pt50	ST RGW 1057 1985 (TC = $3.91 \cdot 10^{-3} 1/^{\circ}\text{C}$)	2/3-wire 2/3-wire 4-wire 4-wire	-200 to +100 °C -200 to +1100 °C -200 to +100 °C -200 to +1100 °C	± 0.5 °C ± 0.9 °C ± 0.5 °C ± 0.6 °C	500 μA 250 μA 500 μA 250 μA
Cu 50	GOST 6651-94 A.3 (TC = $4.28 \cdot 10^{-3} 1/^{\circ}\text{C}$)	2/3-wire 2/3-wire 4-wire 4-wire	-50 to +100 °C -50 to +200 °C -50 to +100 °C -50 to +200 °C	± 0.5 °C ± 0.9 °C ± 0.5 °C ± 0.6 °C	500 μA 250 μA 500 μA 250 μA
Cu100	GOST 6651-94 A.4 (TC = $4.26 \cdot 10^{-3} 1/^{\circ}\text{C}$)	2/3-wire 4-wire	-50 to +200 °C -50 to +200 °C	± 0.5 °C ± 0.5 °C	500 μA 500 μA
Connection circuit	2-, 3-, or 4-wire circuit				
Minimum span	15 °C				
Sensor lead resistance	max. 30 Ω per conductor for 3-wire/4-wire circuit max. 10 Ω per conductor for 2-wire circuit				
Range start/end	freely programmable within the limits in 0.1 °C steps				
Sampling cycle	3 or 6 channels, 250 msec				
Input filter	2nd order digital filter; filter constant adjustable from 0 to 10 sec				
Test voltage for electrical isolation	350 V (via optocoupler)				
Resolution	> 14 bit				

Transducer short circuit/break

	Short circuit ¹	Break ²
Thermocouple	not detected	detected
RTD	detected	detected
Voltage ≤ 210 mV	not detected	detected
Voltage > 210 mV	not detected	not detected
Current	not detected	not detected

² Programmable reaction of device, e.g. trigger an alarm

Binary inputs (option)

Quantity	4, to DIN 19 240; 1 Hz max., 32 V max.
Level	logic "0": -3 to +5 V, logic "1": 12 – 30 V
Sampling cycle (binary inputs, without counter function)	1 sec
Count frequency (binary inputs, with counter function)	30 Hz max.
Auxiliary voltage (output)	24 V ±10%, 50 mA (short-circuit proof)

Outputs (option)

3 relays	changeover (SPDT) (3 A, 230 V)
----------	--------------------------------

Interfaces

Setup interface (standard)	to read and write measurements, instrument, and configuration data (Modbus protocol)
RS 232 / RS 485 (extra code)	to read and write measurements, instrument, and configuration data (Modbus protocol)
Ethernet (extra code)	to read and write measurements, instrument and configuration data (Modbus-TCP protocol)

Screen

Resolution	320 x 240 pixels
Size	5"
Number of colors	27 colors
Screen refresh rate	≥150 Hz
Contrast setting	adjustable on instrument
Screen saver (switch-off)	After elapsed time or control signal

Electrical data

Supply (switch-mode PSU)	110 – 240 V AC +10/-15 %, 48 – 63 Hz or 20 – 53 V AC/DC, 48 – 63 Hz
-----------------------------	--

Test voltages (type test) -electrical supply to measuring circuit - electrical supply to housing (protective earth) - measuring circuits to other measuring circuits and housing - electrical isolation between the analog inputs	to EN 61 010, Part 1, March 1994 overvoltage category II, pollution degree 2 for supply voltage: AC 2.3 kV/50 Hz, 1 min, for supply voltage: AC/DC 510 V/50 Hz, 1 min, for supply voltage: AC 2.3 kV/50 Hz, 1 min, for supply voltage: AC/DC 510 V/50 Hz, 1 min 350 V/50 Hz, 1 min up to 30 V AC and 50 V DC
Supply voltage error	< 0.1 % of range span
Power consumption	approx. 25 VA
Data backup	see page 6
Electrical connection	At the back, via pluggable screw terminals, conductor cross-section $\leq 2.5 \text{ mm}^2$ or $2 \times 1.5 \text{ mm}^2$ with core end ferrules.
Electromagnetic compatibility (EMC) - interference emission - interference immunity	EN 61 326-1 Class A - only for industrial use - to industrial requirements
Safety regulations	to EN 61 010
Enclosure protection	to EN 60 529 category 2, front IP54, back IP20
Ambient temperature range	0 to +50 °C
Ambient temperature error	0.03 %/ °C
Storage temperature range	-20 to +60 °C

Housing

Housing type - housing door	housing for flush panel mounting to IEC 61 554, galvanized steel sheet zinc die-casting
Bezel size	144 mm x 144 mm
Depth behind panel	214 mm, including connectors
Panel cut-out	$138^{+1.0} \text{ mm} \times 138^{+1.0} \text{ mm}$
Panel thickness	2 – 40 mm
Housing mounting	in panel to DIN 43 834
Climatic conditions	$\leq 75\%$ relative humidity, no condensation
Operating position	unrestricted, but taking into account the viewing angle of the screen, horizontally $\pm 50^\circ$, vertically $\pm 30^\circ$
Enclosure protection	to EN 60 529 Category 2, IP54 front (IP65 with extra code 266), IP20 back
Weight	approx. 3.5 kg

Approvals/marks of conformity

Mark of conformity	Testing laboratory	Certificates / certification numbers	Test basis	valid for
c UL us	Underwriters Laboratories	E xxxxx applied for	UL 61010-1 CAN/CSA-C22.2 No. 61010-1	the flush-mounted instrument; not in conjunction with carrying case option

Operation & configuration

On the recorder Configuration is menu-
led, using 8 keys. Three of these have
fixed functions (Enter, Menu, Exit), and
five alter their function and visual
representation according to the menu.
The active functions are shown on the
bottom edge of the screen, so that key
functions are unambiguous during use.

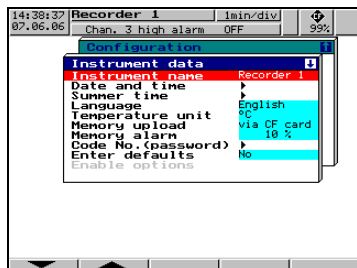

The configuration on the recorder is
protected from unauthorized access by
a passcode.

Via setup program for PC (accessory)

Instrument configuration via the setup
PC software can be more convenient
than using the instrument
keys.

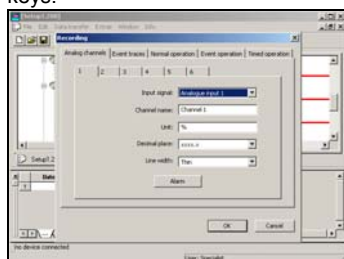

The configuration data can be created
on a data medium (CompactFlash card)
and read by the recorder, or transferred
via one of the communication
interfaces. The PC can be used to write
settings to a printer.

Operating language

The operating language for the
instrument can be selected from various
languages. English, German, French,
Dutch, Spanish, Italian, Hungarian,
Czech, Swedish, Polish, Danish,
Finnish, Portuguese and Russian.

Evaluation program

The PC evaluation program is a
software that runs under Windows
NT/2000/XP/Vista/Win7, and is used to

manage, archive, visualize and
evaluate the recorder data stored on a
CompactFlash card.

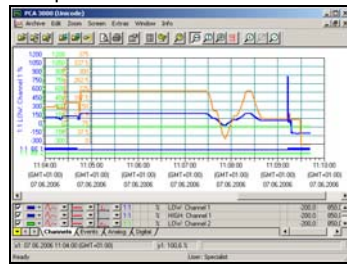

The data from the DataVU5 is read by
the evaluation program and saved in an
archive file. Life-cycle data
management, if needed, ensures that
all data throughout the lifetime of a
system can be saved in an archive file.
Changes to the configuration are shown
separately, along with the
corresponding measurement data.

The user can access different
configuration data sets at any time,
these can be distinguished by
supplementary naming information.

Any analog channels or event traces of
a paperless recorder can subsequently
be combined into PCA groups

Since each group is displayed in a
separate window, several groups can
be shown and compared
simultaneously on the screen.

Operation is possible by mouse or keys.

The export filter makes it possible to
transfer stored data for processing in
another program (e.g. Excel).

The evaluation program supports multi-
user network capability, i. e. several
users can obtain data from the same
database in the network, independently.

PCA communication software (PCC)

The data can be read by the paperless
recorder via the rear serial interface
(RS232/RS485), via the Ethernet
interface, or via the front panel setup
interface. The data can be read
manually or automatically (e. g. daily at
23.00 hrs).

Data can also be retrieved via remote
control, through a modem.

Interface

The current process data, configuration
data and special instrument data can be
read via the optional RS232/RS485 or
Ethernet interfaces, or through the
standard setup interface.

Archived data (FLASH memory) can
also be read by the PCC software.

Serial interfaces

When using the RS232 interface, a
maximum cable length of 15 m is
permitted.

A cable length of up to 1.2 km is
supported for the RS485 interface.
Connection is via a 9-pole SUB-D
connector (for RS232/RS485) on the
rear of the instrument, or on the front
(via the setup interface).

Modbus and Jbus protocols are
available, and the transmission mode
used is RTU (Remote Terminal Unit).
The changeover between the RS232
and the RS485 interface is made
through the program (configuration).

Ethernet interface

Connection is by a RJ45 socket on the
back of the instrument, Modbus/TCP is
supported. The maximum transmission
rate is 10 Mbit/sec.

Options

Counters/integrators/ operating time counters

6 additional internal channels are
available for use as counters,
integrators or operating time counters.
These counters are controlled through
the binary inputs, the alarms, or via the
logic channels. Numerical indication is
shown in a separate window, with a
maximum of 9 digits. The acquisition
period options can be selected as:
daily, weekly, monthly, yearly as well as
externally, total (overall count) or daily
from...to

Counter/Int1 Channel 1	+34
Counter/Int2 Channel 2	+1
Inlet Channel 3	+1408
Outlet Channel 4	+4666
Pump 1 Service water	+138
Pump 2 Fresh water	+133

Math/logic module

The math and logic module (only
configurable via the setup software)
enables, for instance, the combination
of analog channels with one another,
with counters and/or with the binary
inputs. Operators available for formulae
are: +, -, *, /, (,), Sqrt(), MIN(), MAX(),
SIN(), COS(), TAN(), **, EXP(), ABS(),
INT(), FRC(), LOG(), LN(), humidity,
moving average or !, &, |, ^, as well as (and).

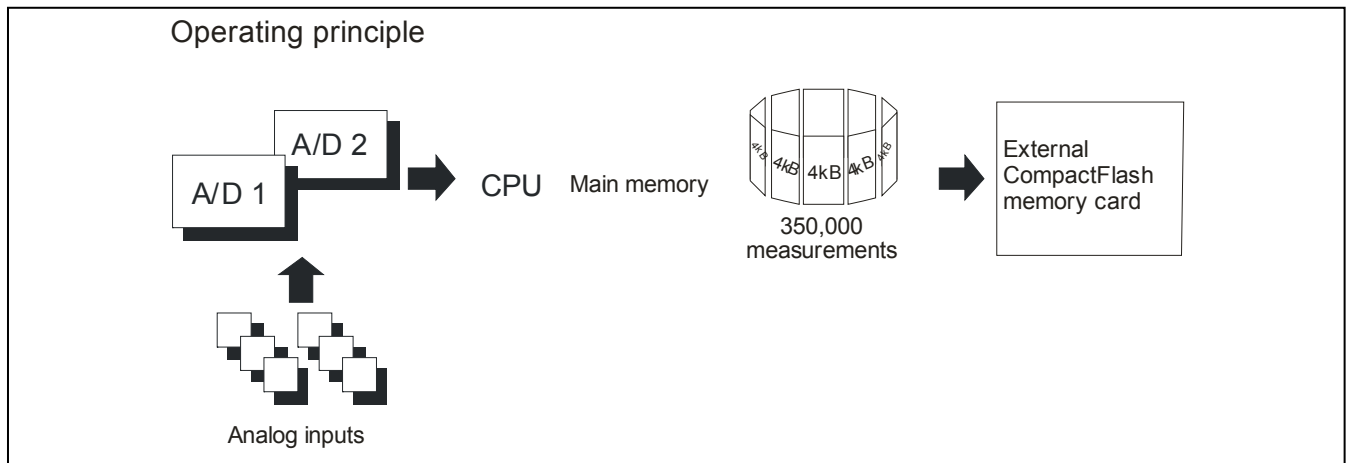

Data Processing

Measurements from the analog inputs are acquired continuously in a 250 ms sampling cycle. These measurements are also used as the basis for limit monitoring. Measured data is transferred to the main memory of the instrument, based on the configurable stored cycle and value (average, momentary value, - maximum, minimum, or peak value).

Main memory (FLASH memory)

The data stored in the main memory is regularly copied to the Compact Flash card in 4 kbyte blocks. The main memory is written to as FIFO memory (First-In First-Out), i.e. when it is full, the oldest data will automatically be overwritten by new data. Memory capacity is sufficient for approx. 350,000 measurements.

The instrument monitors the capacity of the main memory and activates the "Memory alarm (internal)" signal if the level falls below a configurable residual capacity.

CompactFlash card

For saving the data, industrial grade Compact Flash cards can be used with the storage capacities up to 2 GB. The instrument monitors the capacity of the CompactFlash card, and activates the "Memory alarm (CF card)" signal if available memory falls below a configurable level. The signals can be used, for instance, to operate a relay (warning signal "Swap CF card").

Data security

The data is stored in coded form in a proprietary format.

If the CompactFlash card is removed from the instrument, no data will be lost immediately, as the data is still stored in the internal FLASH memory.

A loss of data will only occur the CompactFlash card has been removed, and the internal FLASH memory is completely overwritten.

Response to disconnection of the instrument from the electrical supply

- Configuration and measurement data will be retained, even after the paperless recorder has been disconnected from the electrical supply.
- The internal lithium battery, supplied ex-factory, will retain un saved data for ≥ 10 years or the charged capacitor (available on request) for 2 weeks typically.

Recording duration

Depending on the instrument configuration, the duration of recording can vary over a considerable range from a few days up to several months.

Limit monitoring/ operating mode changeover

An over/underlimit condition will trigger an alarm. This alarm can be output through a relay or used as a control signal for changing the operating mode from normal/timed operation to event operation. The storage cycle and stored value can be configured separately for all three operating modes.

By using the alarm delay function, brief occurrences of over/underlimit conditions can be filtered, so that no alarm is generated.

Normal operation

If the instrument is **not** in event operation and **not** in timed operation, then normal operation is active by default.

Timed operation

Timed operation is active on a daily basis, within a programmable time period.

Event operation

Event operation is activated/terminated by a control signal (binary input, combination alarm). As long as this control signal is active, the instrument is in event operation.

The operating modes have different priorities

Operating mode	Priority
Event operation	1 (higher)
Timed operation	2
Normal operation	3 (lower)

Main menu

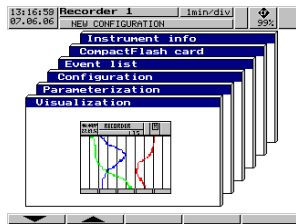

- Layered menu levels
- visualization
 - parameterization
 - configuration
 - event list
 - CF card manager
 - device info

Visualization



Display mode "Measurements" (numerical display)

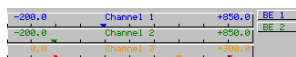

Display mode "Scaling" including limit markers

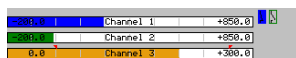

Display mode "Bar graph" including limit markers

Configuration

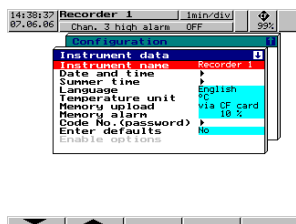

- Configuration from instrument keys
- Password-protected
- Configuration can be transferred to CF card
- Configuration data can be read/edited

Visualization

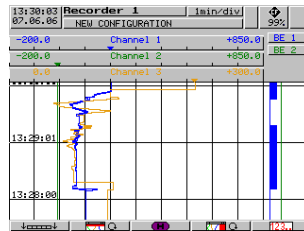

Analog channels and event traces
In addition to plotted curves, measurements can be shown in numerical form, scaled or as a bar graphs.
Softkeys can be visible or hidden.

Visualization

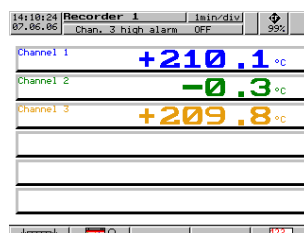

The graphical presentation can be switched off in favor of a larger numerical display.

Parameterization



- General settings without password
- Selection of presentation mode, such as: analog data and/or event traces with/without channel line

Visualization

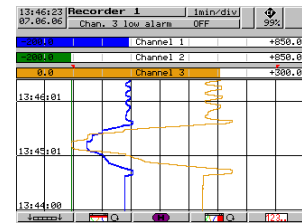

Graphical presentation of the analog channels (without event traces)
Display of scaling and limit markers for the channels

History presentation

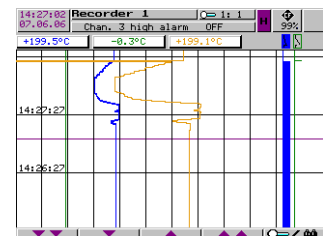

All measurement data stored in the main memory are shown as curves at different zoom levels.

Numerical display of measurements for analog channels at the cursor position.

Shifting of the visible section within the stored measurement data.

The maximum or minimum value display can be changed within the channel line when recorded as an envelope.

Event list

Time	Event	Channel	Status
07.06.06 14:37:38	Chan. 3 high alarm	Chan. 3	OFF
07.06.06 14:37:38	Chan. 3 low alarm	Chan. 3	OFF
07.06.06 14:37:37	Chan. 3 high alarm	Chan. 3	ON
07.06.06 14:37:37	Chan. 3 low alarm	Chan. 3	ON
07.06.06 14:37:31	POWER ON		
07.06.06 14:37:25	POWER OFF		
07.06.06 14:28:57	Chan. 3 high alarm	Chan. 3	OFF
07.06.06 14:28:57	Chan. 3 low alarm	Chan. 3	OFF
07.06.06 14:28:56	Chan. 3 high alarm	Chan. 3	ON
07.06.06 14:28:56	Chan. 3 low alarm	Chan. 3	ON
07.06.06 14:28:51	POWER ON		
07.06.06 14:28:23	POWER OFF		
07.06.06 14:23:56	Chan. 3 high alarm	Chan. 3	OFF
07.06.06 14:23:56	Chan. 3 low alarm	Chan. 3	OFF
07.06.06 14:23:55	Chan. 3 high alarm	Chan. 3	ON
07.06.06 14:23:55	Chan. 3 low alarm	Chan. 3	ON

Important events in plain text (alarm messages, external texts or system messages)

Rear view of a 3 / 6-channel paperless recorder with pluggable screw terminals

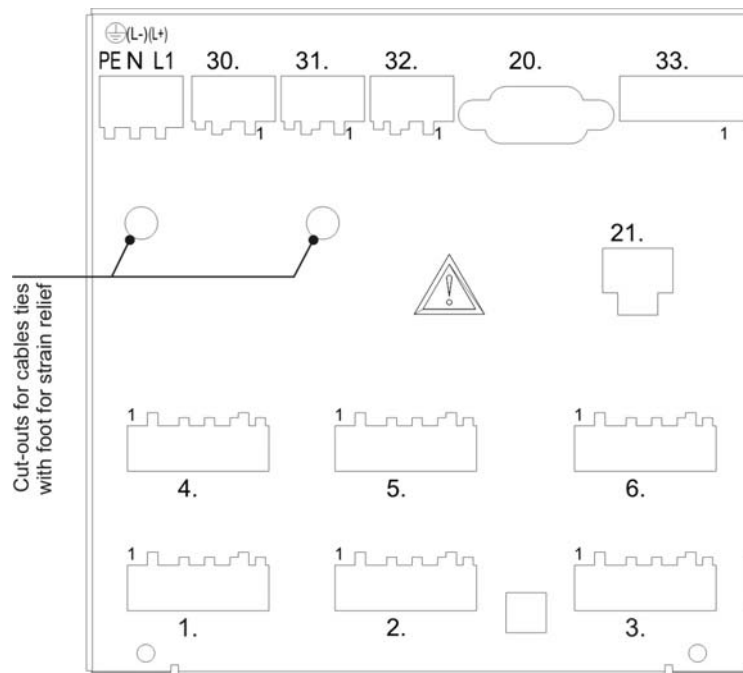

Terminal assignments for 3 / 6-channel paperless recorder

Diagram

Terminal assignments for 3 / 6-channel paperless recorder	Connector	Diagram
Analog inputs	Connector	
Thermocouple	1 to 6	
RTD in 2-wire circuit	1 to 6	
RTD in 3-wire circuit	1 to 6	
RTD in 4-wire circuit	1 to 6	
Voltage input ≤ 210 mV	1 to 6	
Voltage input > 210 mV	1 to 6	
Current input	1 to 6	

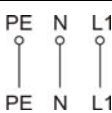
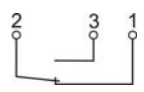
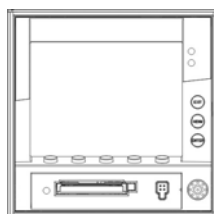
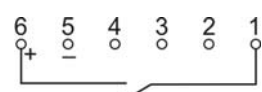
Supply			
Supply	 PE N (L-) L1 (L+)		
Relay outputs (extra code)			
Relays K1, K2, K3 changeover (SPDT)	30, 31, 32		
Setup interface (included in delivery)			
The setup interface can be found behind a protective flap on the front of the instrument.			
Interfaces (option)			
RS232 9-pole SUB-D socket (switchable to RS485)	20	2 RxD 3 TxD 5 GND	Received Data Transmitted Data Ground
RS485 9-pole SUB-D socket (switchable to RS232)	20	3 TxD+/RxD+ 5 GND 8 TxD-/RxD-	Transmitted/Received Data + Ground Transmitted/Received Data -
Ethernet RJ45 socket	21	1 TX+ 2 TX- 3 RX+ 6 RX-	Transmitted Data + Transmitted Data - Received Data + Received Data -
Binary inputs (option)			
Supply voltage 24 V/50 mA Binary inputs voltage-controlled LOW = -3 to +5 V DC HIGH = 12 to 30 V DC	33 6 +24 V auxiliary supply 5 GND 4 binary input 1 3 binary input 2 2 binary input 3 1 binary input 4	 Example: binary input 4, operated from the internal supply voltage	

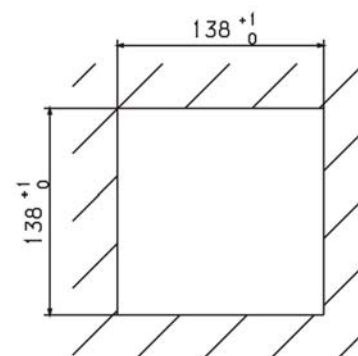
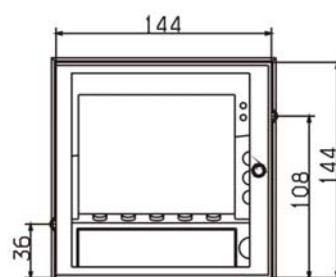
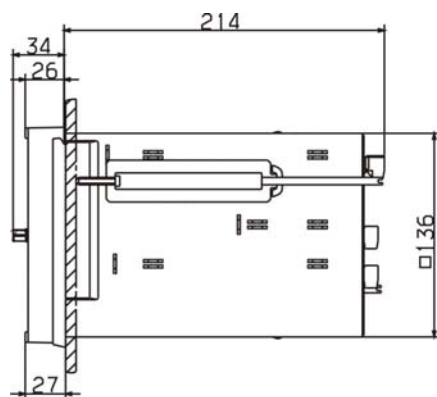

Ordering information

	VU5	X	X	X	X	X
INPUT SLOT 1		↓				
3 Universal Inputs		3				
6 Universal Inputs		6				
Power supply options			↓			
110 - 240V AC, 48-63 Hz			0			
20 - 53V AC/DC, 48-63 Hz			1			
Option 1				↓		
Lithium battery for memory				0		
Lithium battery for memory plus Ethernet interface				1		
Capacitor for memory buffering				2		
Capacitor for memory buffering plus Ethernet interface				3		
Option 2					↓	
none					0	
Mathfunction module &					1	
4 DI / 3 Relay outputs & RS232/485					2	
Mathfunction module &					3	
4 DI / 3 Relay output & RS232/485						↓
Option 3						↓
none						0
IP65 deal with wide mounting brackets						1
Universal carrying case						2
IP65 deal with wide mounting brackets & Universal carrying case						3

Items highlighted are special options, contact your local sales office for availability

Accessories

PC-Interface Cable USB
 Setup PC software
 PCC Communication PC software
 PCA3000 Evaluation PC software
 CF-card memory 256MB
 CF- card memory 1GB

Part Code

DV-PCI
 DV5PCSETUP
 DVPCC
 DVPCEVAL
 DVCF256
 DVCF1000

West Control Solutions – International Sales and Support

CHINA

Danaher Setra-ICG (Tianjin Co., Ltd.
 No.28 Wei 5 Road,
 The Micro-Electronic Industry Park TEDA,
 Xiqing District, Tianjin 300385
 Tel: +86 22 8398 8098 Fax: +86 22 8398 8099
 Sales Hotline: 400 666 1802
 e-mail: EnquiriesChina@West-CS.com

GERMANY

PMA Prozeß- und, Maschinen- Automation GmbH,
 Miramstraße 8, 7D -34123 Kassel
 Tel: +49 (561) 505-1307 Fax: +49 (561) 505-1710
 e-mail: EnquiriesGermany@West-CS.com

USA

West Control Solutions
 1675 Delany Road, Gurnee, IL 60031-1282
 Tel: 800 866 6659 Fax: 847 782 5223
 e-mail: InquiriesUSA@West-CS.com

FRANCE

Tel: +33 (1) 77 80 90 40 Fax: +33 (1) 77 80 90 50
 e-mail: EnquiriesFrance@West-CS.com

UNITED KINGDOM

West Control Solutions
 The Hyde Business Park, Brighton, East Sussex, BN2 4JU
 Tel: +44 (0)1273 606271 Fax: +44 (0)1273 609990
 e-mail: EnquiriesUK@West-CS.com

Brochures and datasheets are available for the complete range of West Control Solutions products, contact your local sales office or visit our website at: www.west-cs.com for more information.

Specifications are subject to change without notice, as a result of continual development and improvement, E&OE